

Honeywell

CK67 Series

Mobile Computer powered by Android™

User Guide

Disclaimer

Honeywell International Inc. (“HII”) reserves the right to make changes in specifications and other information contained in this document without prior notice, and the reader should in all cases consult HII to determine whether any such changes have been made. HII makes no representation or warranties regarding the information provided in this publication.

HII shall not be liable for technical or editorial errors or omissions contained herein; nor for incidental or consequential damages resulting from the furnishing, performance, or use of this material. HII disclaims all responsibility for the selection and use of software and/or hardware to achieve intended results.

This document contains proprietary information that is protected by copyright. All rights are reserved. No part of this document may be photocopied, reproduced, or translated into another language without the prior written consent of HII.

Copyright © 2024 Honeywell Group of Companies. All rights reserved.

Web Address: sps.honeywell.com.

Trademarks

Google and Android are trademarks of Google LLC.

Bluetooth trademarks are owned by Bluetooth SIG, Inc., U.S.A. and licensed to Honeywell.

Other product names or marks mentioned in this document may be trademarks or registered trademarks of other companies and are the property of their respective owners.

Patents

For patent information, refer to www.hsmpats.com.

TABLE OF CONTENTS

Customer Support	xi
Technical Assistance	xi
Product Service and Repair	xi
Limited Warranty	xi
Chapter 1 - About the Computer Features.....	1
About the CK67 Mobile Computer	1
Model Overview	1
Features of the CK67	3
About the Battery	5
Battery Identification	5
Battery Recommendations and Safety Precautions	5
Safety	6
Use and Storage	7
Charge the Battery Before Use.....	8
About the USB Type C Connector	8
Change the Battery	8
Hot Swap.....	8
Remove the Battery	9
Install the Battery.....	10
About the Battery Status.....	10
About the Battery Status LED Setting.....	11
Change the Battery Status LED Behavior	12
Check the Battery Level, Health and Usage.....	13
Install the Hand Strap (Optional)	14

Power On the Computer.....	14
Welcome Screen	14
Unlock the Screen.....	15
Unlock with Face Unlock.....	15
Change the Screen Lock to Protect the Computer.....	15
Set Up Face Unlock.....	16
Select a Touch Screen Profile to Optimize Performance	17
Configure the Screen Backlight.....	17
About the Scan Status LED	18
About the Keypad.....	19
Keypad LEDs	21
About the Color-Coded Keys.....	21
Enter Characters on Alphanumeric Keypads	21
51-Key Keypad	21
53-Key Keypad	22
Enter Characters on Numeric Keypads	24
38-Key Keypad	24
42-Key Keypad	25
Enter Characters on the Large Numeric Keypad.....	26
About the Audio Features	28
Adjust Speaker Volume	28
Enable Vibrate Mode.....	29
Audio Settings	29
Insert a microSD Card.....	30
How to Transfer Files.....	31
Configure USB Connection and Transfer Files	32
Accessories for the Computer.....	32

Chapter 2 - About the User Interface and Applications 35

About the User Interface.....	35
Navigation and Function Buttons	36
About Status Bar Icons	37
Remap a Button or Key.....	38

Restore Default Button Action.....	39
View and Manage Notifications.....	39
Open Quick Settings.....	39
Customize the Home Screen	40
Customize the Favorites Tray.....	40
Use Google Search.....	40
About Screen Gestures.....	41
Set the Time Zone.....	41
About Honeywell Applications	42
Applications You Can Download to the Mobile Computer	43
About Honeywell Enterprise Browser	43
About Honeywell Launcher.....	44
About Terminal Emulators	44
About UEMConnect	44
Unlock Developer Options.....	45

Chapter 3 - Use the Imager47

About the Image Engine.....	47
About the Scan Wedge Feature.....	47
Change the Scanner Settings	48
Restore Default Scan Settings	48
Default Scan Settings	49
Data Processing Settings.....	49
Symbology Settings	50
Decode Settings	50
Imager Settings	53
Trigger Settings.....	54
Notification Settings.....	54
Add a Scan Setting Profile.....	55
Delete a Scan Setting Profile	55
Change the Bluetooth Scanner Settings	55
About the Optional Digital Scan Button	56
Enable and Configure the Digital Scan Button	56
Scan Barcodes.....	57

About Scanning Configuration Barcodes.....	57
Use the Scan Demo App.....	57
Change the Scan Demo Symbology Settings	58
Smart OCR.....	58
Enable Smart OCR.....	59
OCR Settings.....	59
OCR Settings Options	59
Result Regex.....	60
Add Custom Regex.....	61
View or Edit Custom Regex.....	62
Delete Custom Regex.....	62
Sequence Regex	63
Results in Order	63
Regex Results	64
Deploy OCR Settings with EZConfig.....	64
Scan Text Using Smart OCR.....	65

Chapter 4 - Use the Camera..... 67

About the Color Camera.....	67
How to Zoom	67
Take a Photo.....	67
Record a Video	68
Change Camera Settings.....	68
Use the Camera as a Flashlight.....	69

Chapter 5 - Configure the Computer..... 71

How to Configure the Computer.....	71
Start the Settings App	71
About the Structure of the Settings App	71
About Network Communications	83
Connect to a Wi-Fi Network	83

Configure Proxy Settings for a Wi-Fi Network.....	84
Disable Wi-Fi Notifications	84
Fix Connectivity	85
Honeywell Wi-Fi Settings	85
Connect to an Ethernet Network.....	85
How to Connect to Virtual Private Networks.....	86
Add a VPN.....	86
Connect to a VPN	86
Edit VPN Information	87
About Wireless Security	87
About Certificates.....	87
Load a Certificate.....	88
Disable or Remove Certificates	88
About Bluetooth Communications	89
Connect a Bluetooth Device.....	89
Rename the Computer	90
Rename, Share or Unpair a Paired Device.....	90
About the Scanner Edge App	90
Connect a Bluetooth Scanner	91
Unpair a Paired Scanner	91
About Serial and USB Communications	92
USB Troubleshooting	92
About Near Field Communication (NFC)	92
Read an NFC Tag	93
Developer Information	93
About Provisioning Mode	93
Enable or Disable Provisioning Mode	94
About Wi-Fi Staging	94
Staging Devices.....	94
Set Up a Device as a Server.....	94
Advanced Configuration	96
Set Up Client Devices	97
Log Files	98
About Voice Wedge.....	98

Define Trigger Mode.....	98
Associate Applications	99
Define Key Commands.....	99
Select Data Type	99
To Use Voice Wedge in an App	100

Chapter 6 - Configure RFID Settings.....101

About RFID Readers.....	101
Change the RFID Settings.....	101
Restore Default Scan Settings	102
Default RFID Settings.....	102
RFID Reader Settings	102
Filter Settings	104
Trigger Settings	104
Notification Settings	104
Data Processor Settings.....	105
Add an RFID Profile	106
Delete an RFID Profile	106

Chapter 7 - Manage and Maintain the Computer.....107

About Software Updates and Cyber Security	107
Software Downloads	107
About Transferring Files via USB Connection	108
Install Software with AutoInstall.....	108
Optional microSD Card Method.....	109
About the Honeywell Upgrader	109
Restart (Reboot) the Computer.....	109
About Enterprise Data Reset.....	110
Before You Begin	110
Enterprise Data Reset the Computer	110
About Erase All Data (Factory Reset).....	111
Before You Begin	111
Erase All Data (Factory Reset).....	111

Repairs.....	112
Maintenance.....	112
Clean the Computer	112

Appendix A - Specifications 113

Computer Agency Information	113
Label Locations.....	113
Physical and Environmental Specifications	114
Barcode Symbolologies Supported	114
S0703-SR Standard Range Imager Reading Distances.....	115
S0703-SR Standard Range Imager Field of View/Resolution.....	116
S0803-FR FlexRange Imager.....	116
S0803-FR FlexRange Imager Field of View/Resolution	118
Near Field Optical System.....	118
Far Field Optical System.....	119
S0803-LR FlexRange XLR Imager Reading Distances.....	119
S0803-LR FlexRange XLR Imager Field of View/Resolution.....	120
Near Field Optical System.....	120
Far Field Optical System.....	120

Customer Support

Technical Assistance

Go to honeywell.com/PSStechnicalsupport to search our knowledge base for a solution or to log into the Technical Support portal.

For our latest contact information, see honeywell.com/PSSlocations.

Product Service and Repair

Honeywell International Inc. provides service for all of its products through service centers throughout the world. Go to sps.honeywell.com, then select **Support > Productivity** to find a service center near you or to get a Return Material Authorization number (RMA #) before returning a product.

For ongoing and future product quality improvement initiatives, the mobile computer comes equipped with an embedded device lifetime counter function. Honeywell may use the lifetime counter data for future statistical reliability analysis as well as ongoing quality, repair and service purposes.

Limited Warranty

For warranty information, go to sps.honeywell.com and click **Support > Productivity > Warranties**.

ABOUT THE COMPUTER FEATURES

This chapter introduces the CK67 Mobile Computer. Use this chapter to learn about the basic computer features, functions, and accessories.

Note: *Throughout this manual, all versions of the mobile computer are referred to as the CK67 unless information is specific to a particular model type. The device applications and settings vary by computer model and OS version. Your computer may not include all the features shown in the manual.*

About the CK67 Mobile Computer

Honeywell's CK67 mobile computers, built on the newest generation Mobility Edge™ platform, deliver real-time connectivity, advanced data capture, and future-proof investment protection. All models come equipped for fast Wi-Fi connectivity with a WLAN 802.11 a/b/g/n/ac/d/h/i/r/k/v/w/mc/ax, 2x2 MU-MIMO radio, Bluetooth (v5.3) technology that includes Bluetooth® Low Energy (BLE) support, and integrated Near Field Communication (NFC) technology. The CK67 Series also includes front and rear-facing color cameras, a USB Type C connector for both charging and communication use, and multiple keypad options.

The CK67 offers the added benefit of a hot swap battery feature as well as Device Finder app compatibility when the mobile computer is registered with Operational Intelligence™. The CK67 Series also includes advanced Wi-Fi™ 6E technology support.

Note: *The Settings app varies by computer model and OS version. Your computer may not include all the features shown throughout the manual.*

Model Overview

Available Features	Model CK67X0N
Android operating system*	x
2.4 GHz Qualcomm® QCS4490/QCM4490 octacore processor	x

Available Features	Model CK67X0N
8 GB DDR5 RAM, 128 GB flash memory	x
Choice of Honeywell high-performance 2D imager	x
Choice of physical keypads	x
USB Type C connector for communication/charging	x
Battery hot swap feature	x
Top-tier rugged specifications with IP68 sealing	x
WLAN IEEE 802.11 a/b/g/n/ac/d/h/i/r/k/v/w/mc/ax radio; Wi-Fi certified	x
Bluetooth™ V5.3 and Bluetooth Low Energy (BLE) technology support	x
NFC technology for short-range wireless data exchange	x
Customer-accessible microSD™ slot for removable memory cards up to 2TB (SDXC/SDHC/SDIO compliant)	x
13 megapixel rear-facing color camera with video image stabilization and advanced software features for enhanced exposure control	x
8 megapixel front-facing camera	x
Value-added software components supporting specialized imaging and OCR functions	x
High-definition, bright color, outdoor-readable display with responsive multi-touch capacitive touch panel	x
Integrated ambient light sensor, proximity sensor, accelerometer, gyroscope, and magnetometer	x
*For information on supported Android OS versions, see the CK67 Data Sheet, available at sps.honeywell.com .	

Features of the CK67

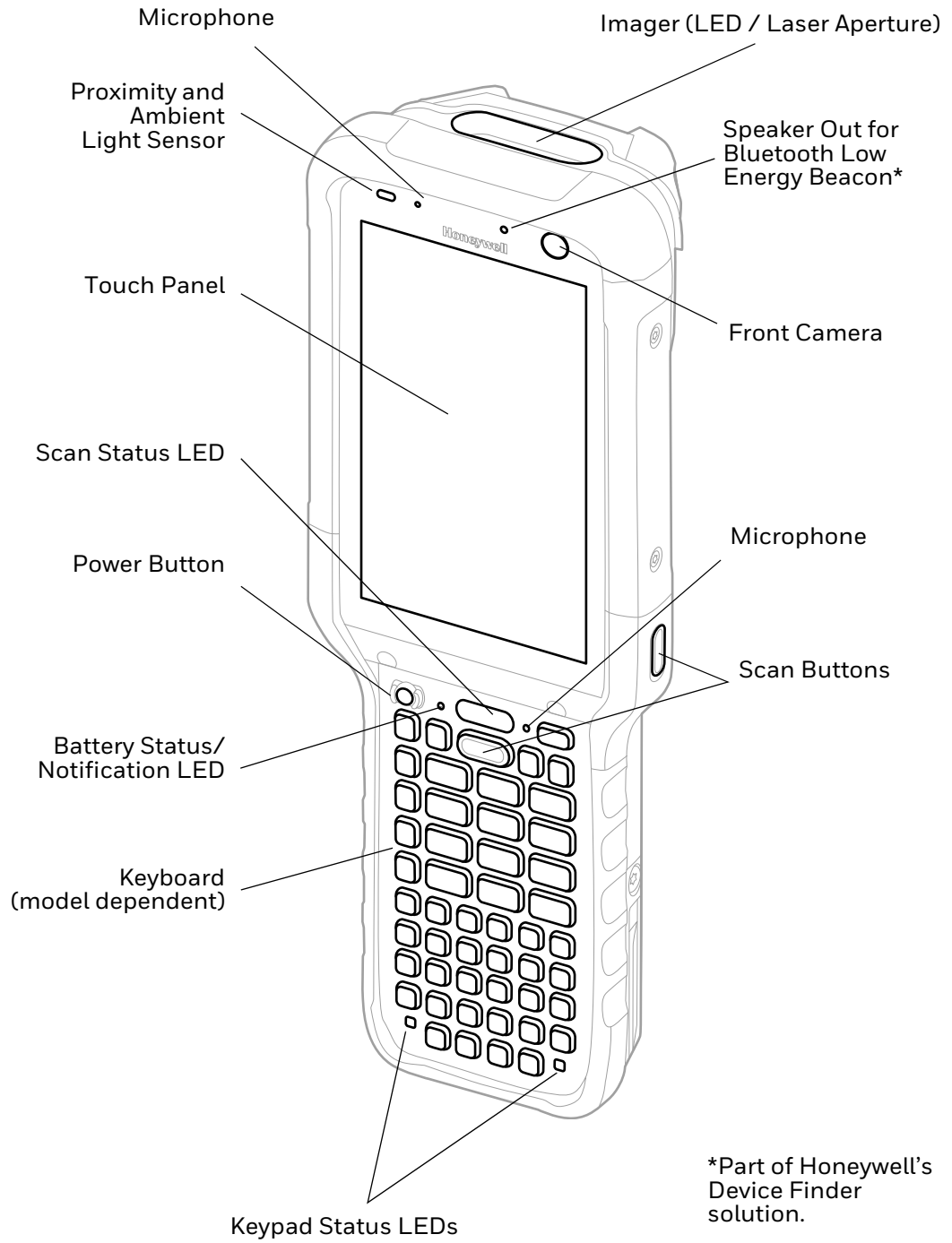

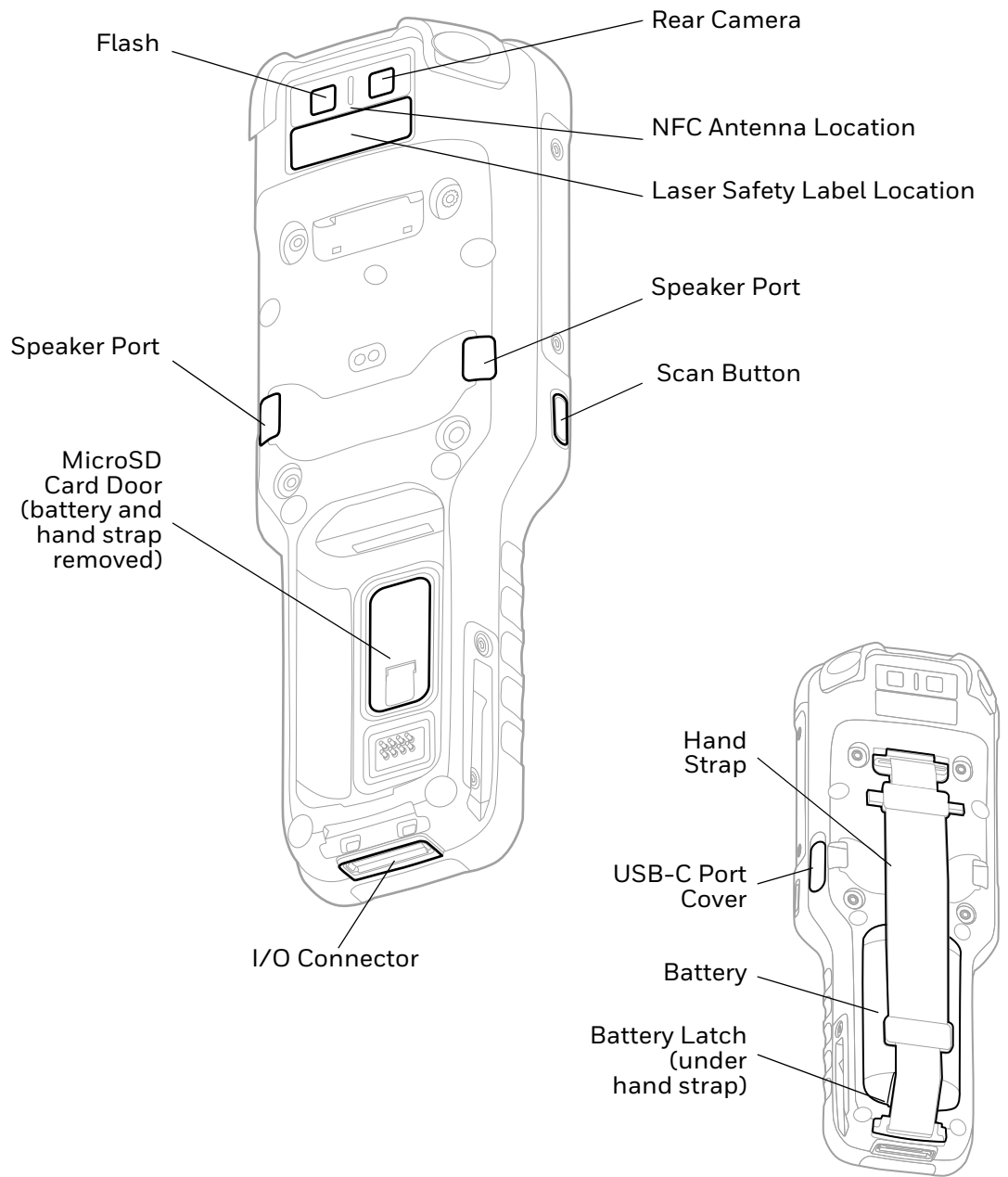

About the Battery

The computer uses a rechargeable Li-ion battery as its main power source. Several factors determine the life of your battery, such as display brightness, display timeout, input device, extreme temperature, and usage.

CK67 computers are designed for use with batteries manufactured for Honeywell International, Inc. See [Battery Identification](#) on page 5 for guidance on the correct battery for your unit configuration.

For a list of compatible accessories, see the CK67 accessories catalog, available for download from the product device page at sps.honeywell.com. Contact your local sales representative for replacement battery ordering information.



Caution: Read [Battery Recommendations and Safety Precautions](#) on page 5 and all cautionary markings on the battery, charging peripheral, and device using the battery before attempting to install, use, or charge the battery.

Battery Identification

Not all batteries are the same due to computer model and/or configuration variations. .

Computer	Battery Model	Battery Part Number	Replacement Battery SKU
CK67	CK65-BTSC	318-063-011	CK67-BTSC-001

Note: Legacy CK65 battery models can also be used with the CK67. Contact your local Honeywell representative for a complete list of compatible batteries and charging accessories.

Battery Recommendations and Safety Precautions

This section provides additional information on the safe use, handling and storage of the Lithium-ion rechargeable battery designed for use with the computer.

To learn more about Battery Maintenance for Portable Devices, go to honeywell.com/PSS-BatteryMaintenance.

Safety



Caution: Before you attempt to charge or replace the battery carefully read all labels, markings and product documentation provided in the box or online at sps.honeywell.com.



Caution: Improper battery replacement or incompatible device usage may result in risk of burns, fire, explosion, or other hazard. Dispose of lithium-ion batteries according to local regulations. Risk of fire and burns if improperly handled. Do not open, crush, heat above 60 °C (140 °F), or incinerate.



Caution: Ensure all components are dry prior to mating the computers and batteries with peripheral devices. Mating wet components may cause damage not covered by the warranty.

- Do not store the battery at temperatures above 60 °C (140 °F), such as inside a car on a hot day or in direct sunlight. Storage above 60 °C (140 °F) may damage the battery.
- Avoid dropping the battery or computer. If you suspect that the battery or computer is damaged or if intermittent power and charging issues occur, send the relevant device(s) to a Honeywell service center for inspection of the computer and/or battery. To learn more about returns refer to [Product Service and Repair](#) on page xi.
- Do not use the battery if it is noticeably deformed, swollen, or discolored. Replace immediately and discard as noted in the Caution at the beginning of this Safety section.
- Do not use the battery if it is too hot to handle. Replace immediately and discard.
- Discarded batteries may create a safety hazard. Before disposal, cover the battery contacts with electrical insulating tape.
- Do not modify the battery or attempt to insert foreign objects into the battery.
- Do not solder directly to the battery contacts.
- Do not drop the battery or apply mechanical shocks or pressure to the battery.
- Do not immerse batteries into, or expose them to, water or seawater.
- Do not incinerate, microwave, throw into a fire, or expose batteries to temperatures above the maximum rating.
- Do not disassemble a battery or try to open or penetrate its housing.
- Stored batteries should be separated, not touching any other battery, device, charger, or accessory.
- Do not store or carry batteries where they are in close proximity to or touching conductive material (metal). For example, in a pocket where zippers, coins and office supplies (e.g., pens, paperclips) could also be located.

Use and Storage

When setting up the computer, you should consider how apps, services, and UI settings affect battery power consumption. Set the screen timeout feature to turn off the screen sooner and enable the Adaptive brightness feature to minimize battery use. Restrict unnecessary apps or services from running in the background to prevent battery drain. Utilize the Battery saver and Battery manager features to conserve power. Turn on Airplane mode to conserve battery power if network connectivity is limited or is not needed.

Keep in mind that Lithium-ion battery capacity declines over time due to stress from repeated charge-discharge cycles and environmental factors such as extreme operating/storage temperatures and humidity. As the battery lifespan/health declines, the battery energy dissipates more quickly or may take longer to charge.

Remember that the battery self-discharges slowly over time, even if the computer is turned off or the battery is stored outside the computer. Environmental factors such as extreme temperature and humidity affect self-discharge rates and can impact the battery the battery lifespan.

Follow the recommendations below for battery use and storage.

- For maximum battery life, charge the CK65-BTSC battery at 20 °C (68 °F) to 25 °C (77 °F) and store at 23 °C (73 °F) with a 50% charge.
- Use only Honeywell approved charging methods and devices. See [Charge the Battery Before Use](#) on page 8. Use of this battery in other devices could result in damage to the device or battery.
- Replace the battery only with a Honeywell replacement battery. See [Battery Identification](#) on page 5 for guidance on the correct battery for your unit configuration. These batteries have been tested in accordance with applicable safety standards. Contact your Honeywell sales representative or distributor if this battery is no longer available.
- Batteries should be replaced periodically, typically every two years or if the battery health falls below 70% (see [Check the Battery Level, Health and Usage](#) on page 13).
- Promptly recharge the battery or replace battery with a charged battery when you notice the battery status icon indicates the charge is low.
- Avoid allowing the battery to be completely drained since this applies stress on the battery and may shorten lifespan.
- Do not store batteries in a charger that is not connected to power.
- If you are storing the computer for a few days (e.g., over the weekend), install a fully charged battery or connect the computer to a power source.
- If you are storing the computer for longer than a few days, remove and charge the battery. When the battery is done charging, store both the battery and the computer separately in a cool and dry location. Periodically check the battery charge level. This is especially critical when storing batteries for several months

since the battery will gradually self-discharge and a fully drained battery can impact the battery lifespan.

Charge the Battery Before Use

The mobile computer ships with a partially charged battery. Charge the battery with a compatible CK65/CK3 charging device for a minimum of **3 hours**.

Note: *Using the computer while charging the battery increases the time required to reach a full charge.*

About the USB Type C Connector

You can use a USB cable to charge the mobile computer from a host device (e.g., laptop or desktop computer). The connected host device must supply a minimum power output of 5V, 0.5A to the mobile computer.

Note: *If the mobile computer is drawing more current than supplied by the charging source, charging will not take place.*

Change the Battery

When battery power is low, you have the choice to either charge the battery in the computer, or replace it with another fully charged battery. Spare batteries can be purchased separately. (See also [Check the Battery Level, Health and Usage](#) on page 13.)



Caution: **Ensure all components are dry prior to placing the battery in the computer terminal. Mating wet components may cause damage not covered by the warranty.**

Hot Swap

The computer includes an internal battery that provides limited power for on-demand replacement of the main battery (i.e., hot swap). The hot swap battery powers the display, Wi-Fi and running apps while the battery is removed and replaced with a charged battery within the specified time period. The internal battery is not user replaceable.

You can hot swap the battery provided the following conditions are met:

- The internal battery is charged (see [Troubleshooting](#)).
- You insert a charged battery within 60 seconds.

Note: *Do not install or remove the microSD card while performing a hot swap.*

Troubleshooting

- The internal battery is charged by the main battery but can be depleted if too many consecutive hot swaps occur over a short time.

- The internal battery may drain faster if you perform a hot swap while multiple apps are running. Extreme temperature may also affect how quickly the internal battery drains.
- If the internal battery is depleted and you attempt a hot swap, the computer will power off and you may lose unsaved data. Once a battery is installed, press the Power button to turn the unit back on.
- If you attempt to hot swap the battery during a phone call, the call will be dropped.

Remove the Battery

1. Either power off the computer or begin a hot swap. See [Hot Swap](#) on page 8.
2. Release one end of the hand strap if installed.
3. While pressing the battery latch towards the battery, lift up on the battery to remove it from the computer.

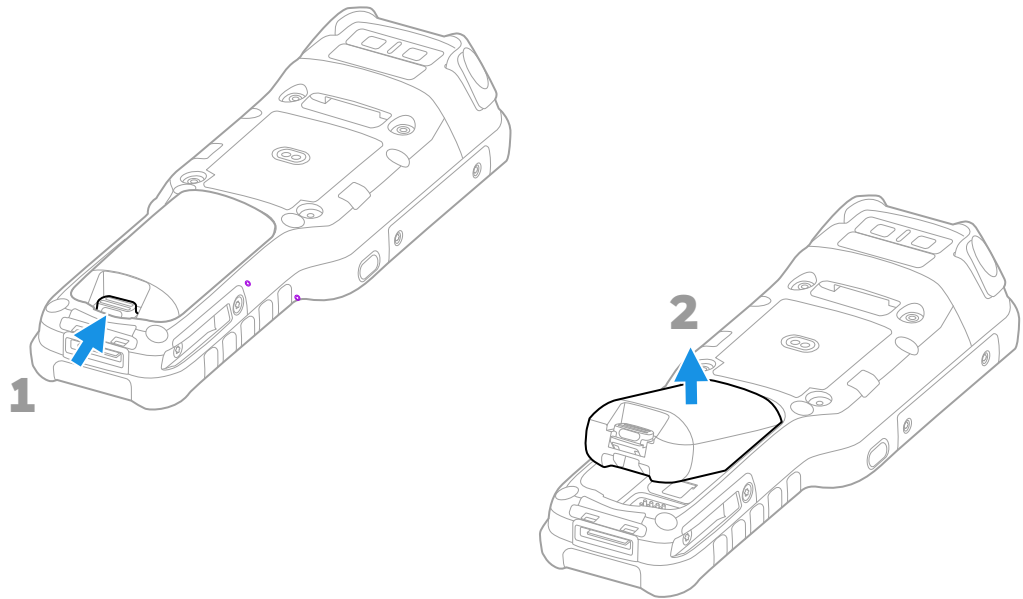

Install the Battery

1. Insert a charged battery into the computer at an angle. See [Battery Identification](#) on page 5.

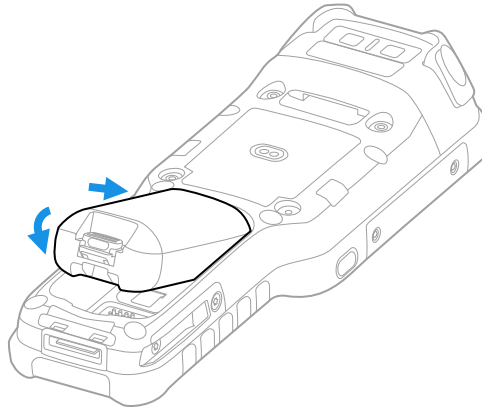

2. Press down on the battery until the battery latch clicks.

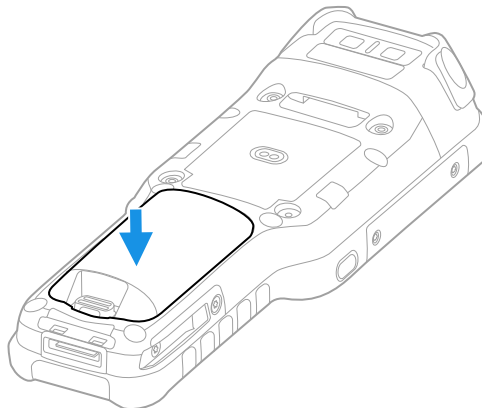

3. Reattach the hand strap, if applicable.
4. If the computer is off, press the **Power** button.







About the Battery Status

To view detailed information on your battery, such as use statistics, amount of charge remaining, and battery health information:

1. Open the **Settings** app .
2. Select either **Battery** or **Honeywell Settings > Battery Optimizer**.

You can also use the battery icon at the top of the screen in the Status bar to see battery charge information. The icon changes depending on the charge level.

Battery Status Icons

Icon	Status
	The battery charge is at 100%.
	The battery charge is at 50%.
	The battery charge is low. You need to charge or replace the battery soon.
	The battery is critically low. You need to replace the battery now or connect the computer to a charging accessory.
	The computer is connected to external power and the battery is charging.
	There is a battery error. Install another battery. If the problem persists, contact Honeywell Technical Support.

Along with the battery icon, there is a battery status LED below the touch screen. The LED color and behavior (e.g., steady on, blinking, or off) indicates the charging status of the battery. To view status descriptions and to learn how to modify the Battery LED behavior, see [About the Battery Status LED Setting](#) on page 11.

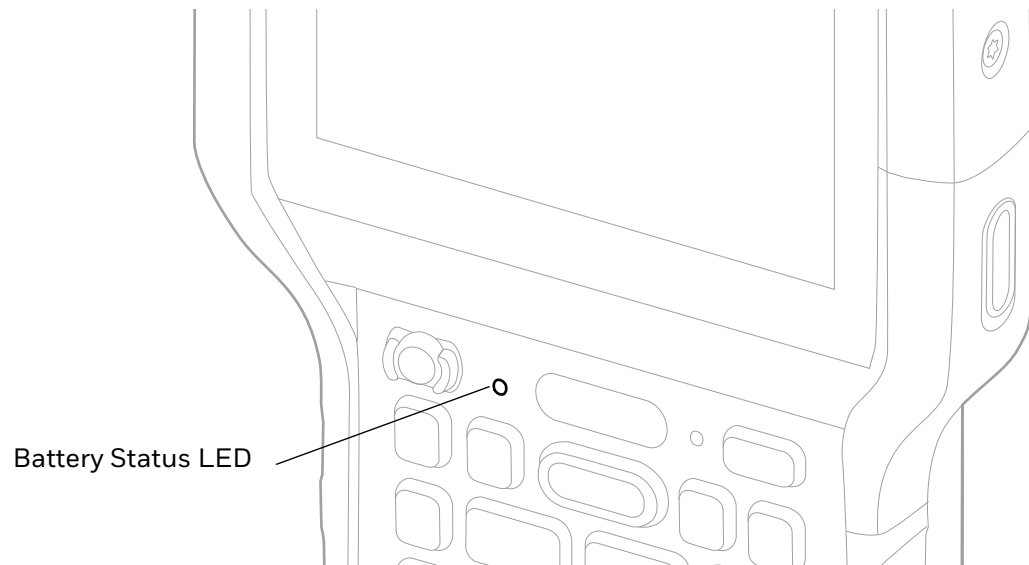

About the Battery Status LED Setting

You can change the behavior of the Battery status LED if the out-of-box behavior for a charging battery (blinking green) is not acceptable to your environment.

You can choose one of three options:

- **Honeywell Battery LED** (factory default, out-of-box configuration)
- **Default Battery LED** (optional Android OS configuration)
- **No Battery LED**
- **Mix Mode**

Honeywell Battery LED Behavior (Factory Default/Out-of-Box Configuration)

Connected to Power	LED State	Description
No	Blinking amber	Battery level is below 15%
No	Off	Battery level is more than 15%
Yes	Steady amber	Battery level is between 0% and 60%
Yes	Blinking green	Battery level is between 60% and 95%
Yes	Steady green	Battery level is above 95%
Either	Blinking red	Battery error

Default Battery LED Behavior (Optional Android OS Configuration)

Connected to Power	LED State	Description
No	Blinking red	Battery level is below 15%
No	Off	Battery level is 15% or more
Yes	Steady red	Battery level is below 15%
Yes	Steady amber	Battery level is between 15% and 90%
Yes	Steady green	Battery level is 90% or more

Select the No battery LED setting if you want to use the LED as a notification LED for applications or device management solutions. For more information on how to use the LED as a notification LED, see <http://developer.android.com/guide/topics/ui/notifiers/notifications.html>.



Change the Battery Status LED Behavior

To change the battery status LED behavior:

1. Swipe up from the bottom of the Home screen to access all apps.
2. Tap **Settings**  > **Honeywell Settings** > **Battery LED**.
3. Choose one of the options:
 - **Mix Mode** (enable customizable configuration)
 - **Default Battery LED** (optional Android OS configuration)
 - **Honeywell Battery LED** (factory default/out-of-box configuration)
 - **No Battery LED** (disable battery LED)

Check the Battery Level, Health and Usage

In addition to the Battery status icon and LED, you can use one of the following methods to monitor the battery status:

1. Swipe up from the bottom of the Home screen to access all apps.
2. Select one of the following:
 - **Settings**  > **Battery**
The current percentage of battery power remaining and the amount of usage time left on the battery appear on the screen. You can also access the **Battery saver** feature from the battery screen.
 - **Settings**  > **Honeywell Settings** > **Battery Optimizer**
View battery status, health and app usage information. Create and enable or disable a power optimization profile that implements a group of settings to conserve power.
 - **Power Tools** > **BattMon**
Refer to the Power Tools user guide available at sps.honeywell.com.

Install the Hand Strap (Optional)

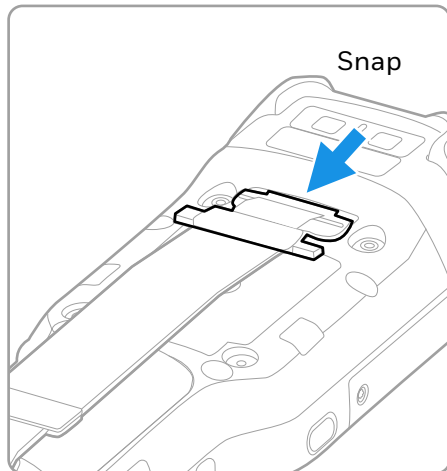
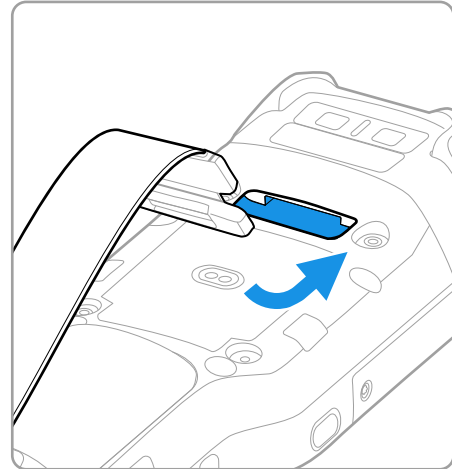
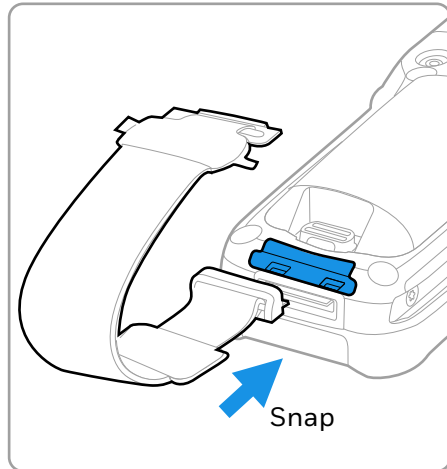

Power On the Computer

After you have fully charged and installed a battery, power on the computer for the first time:

- Press and hold the **Power** button for approximately 3 seconds, and then release the button.

Welcome Screen

The first time you power on the computer, a Welcome screen appears. Select a language and then tap **Start**. You can either scan a configuration barcode or select manual to set up the computer. To learn more about how to [Scan Barcodes](#), see [page 57](#). To learn more about configuring multiple devices using the Wi-Fi Staging app, see [page 94](#).

During the manual setup process, follow the prompts on the screen to:

- Set the default language.
- Set up the Wi-Fi network connections.
- Set the time, date, and time zone if no Wi-Fi connection is available.
- Personalize (name) the computer.
- Set up security and privacy options.

Once you complete the initial setup, the Welcome screen no longer appears when you power on the computer and **Provisioning mode** is automatically turned Off (disabled). Scanning a barcode to install applications, certificates, configuration files, and licenses on the computer is restricted when **Provisioning mode** is turned Off. To learn more [About Provisioning Mode](#), see [page 93](#).

Unlock the Screen

The screen lock automatically activates every time the computer is turned on or when the computer wakes from sleep mode.

- Swipe up from the bottom of the screen.

The level of security provided depends on the type of lock set (e.g., Swipe, Pattern, PIN, Password, or Face Unlock). The default setting, Swipe, provides no protection against unauthorized access to your computer.

Unlock with Face Unlock

Use facial recognition with the front camera to unlock the computer in sleep mode.

1. Press the **Power** button to wake the computer.
2. While the bottom of the lock screen displays a smiling face, hold the front camera in front of your face until the computer unlocks.

If the computer does not recognize your face, a frowning face will display. To retry face unlock, tap the frowning face to display a smiling face.

When face unlock is enabled, you must use a PIN, pattern, or password to unlock the computer after it turns on or restarts.

Change the Screen Lock to Protect the Computer

After you start using the computer, you should change the screen lock to prevent unauthorized persons from accessing the computer after the screen lock activates, unless they input the correct password, pin, or pattern.

The recommended setting for the Screen lock is to enable a Password lock. Use a strong password value (e.g., include numbers, characters, special characters, and mix character case).

1. Swipe up from the bottom of the Home screen to access all apps.
2. Tap **Settings**  > **Security & privacy** > **Device unlock** > **Screen lock**.
3. Choose one of the following options:
 - **None**
 - **Swipe**
 - **Pattern**
 - **PIN**
 - **Password**
4. Follow the on-screen prompts to complete the setup.
5. Exit the Settings app.

Set Up Face Unlock

Face unlock allows you to unlock the computer in sleep mode by using facial recognition with the front camera. A series of on-screen prompts guide you through the process of capturing a face image that you can use to unlock the computer.

Note: *When face unlock is enabled, you must also have a backup method to unlock the computer, such as PIN, pattern, or password.*

1. Swipe up from the bottom of the Home screen to access all apps.
2. Tap **Settings**  > **Security & privacy** > **Device unlock** > **Face Unlock**.
3. If you have not set up a screen lock, you will be prompted to add a backup method for unlocking the computer: PIN, pattern, or password.
4. Follow the on-screen prompts to complete the setup.

You can add multiple face images. To add an additional face image, tap **Add face**.

Select a Touch Screen Profile to Optimize Performance

Optimize screen interactions by selecting a touch screen profile designed specifically for your use case. For example, if you wear gloves, set the touch screen profile to **Glove use enhanced** for the best touch screen response.

Note: *Maximum glove thickness of 2 mm (0.08 inches) for touch screen response.*

1. Swipe up from the bottom of the Home screen to access all apps.
2. Tap **Settings**  > **Honeywell Settings** > **Touch Screen Profile**.
3. Choose one of the following options:
 - **Standard mode**
 - **Glove enhance mode**
 - **Stylus enhance mode**
 - **Protector mode**
 - **Rain mode**
4. Exit the Settings app.

Configure the Screen Backlight

The display has an ambient light sensor that automatically adjusts the backlight intensity to conserve power and ensure the display is readable. You can also manually set the backlight intensity if you do not want to use the automated adaptive brightness feature.

1. Swipe up from the bottom of the Home screen to access all apps.
2. Tap **Settings**  > **Display**.
3. Choose one of the following options:
 - To have the computer automatically adjust the brightness for your work environment, turn on the **Adaptive brightness** setting. You can tap **Adaptive brightness** to toggle the feature on or off.
 - To set the brightness level manually, verify the Adaptive brightness feature is turned off, and then select **Brightness level**. Adjust the slider to set the brightness level.

About the Scan Status LED

The Scan Status LED indicates the read status of the imager when scanning a barcode. The Scan Status LED is located below the touch screen.

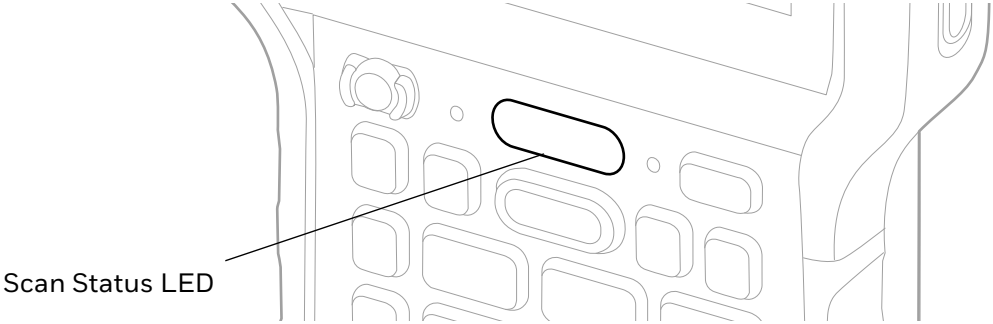

Scan Status LED Descriptions

LED Color	Description
Green	Good read of a barcode.
Red	Failure to scan barcode. Check to make sure you have the correct symbology enabled.

Note: *The behavior of the Scan Status LEDs is determined by the scanning notification settings (see page 54).*

To learn more about how to use and configure the imager engine for scanning, see [Use the Imager](#) beginning on page 47.

About the Keypad

The CK67 is available in a variety of keypad configurations. For additional information about specific keys and how to assign functions, see [Navigation and Function Buttons](#) on page 36 and [Remap a Button or Key](#) on page 38

Alphanumeric Keypads

51-Key



53-Key



Numeric Keypads

38-Key

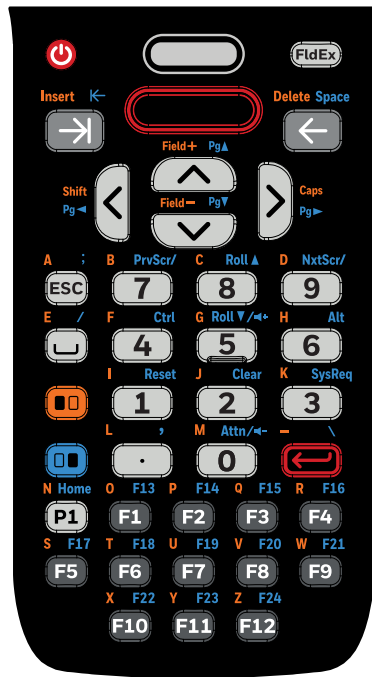

42-Key



Large Numeric Keypad

31-Key



Keypad LEDs

Special characters and alternate functions are entered by pressing color-coded key sequences. Keypad LEDs located at the bottom of the keypad indicate when a color-coded modifier key is active. All models include both orange and blue modifier keys for typing alternate characters, symbols, and functions.

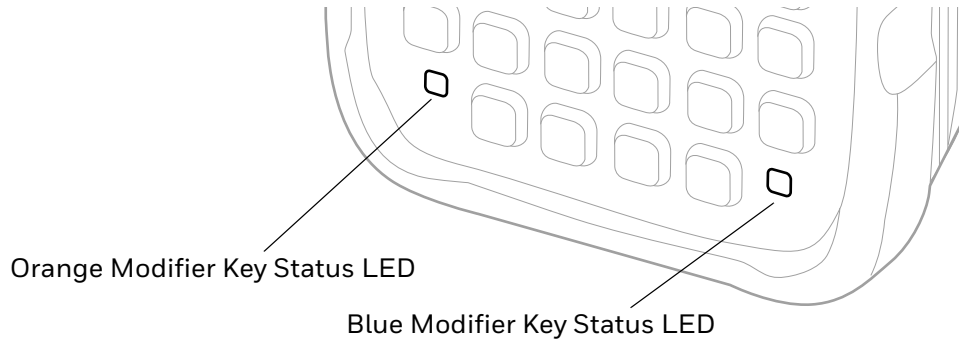

Keypad LED Descriptions

Status LED	Color	Description
Orange Modifier Key Status	Orange	Illuminated when the orange modifier key is enabled.
Blue Modifier Key Status	Green	Illuminated when the blue modifier key is enabled.

About the Color-Coded Keys

Use the keypad color-coded modifier key(s) to access all the characters, numbers, symbols, and functions marked on the computer keys and keypad overlay.

Note: On any keypad, you can lock the modifier key on and type only symbols or special characters by pressing the orange or blue modifier key twice in rapid succession. Press the modifier key again to unlock the modifier.

Enter Characters on Alphanumeric Keypads

51-Key Keypad

Computer models with a 51-key alphanumeric keypad include orange and blue modifier keys for typing symbols and special characters. The keypad also has customizable auxiliary keys (F1 to F5) that can provide up to five additional key functions.

To learn more about customizing the key functions, see [Remap a Button or Key](#) on page 38.

To type an alphabetic character or a number:

- Press the relevant character or number key.

To type a symbol or special character:

1. Press the orange or blue modifier key.
2. Press the key for the symbol or special character.



Example: Press  and then  to type a question mark.

To type a single uppercase alphabetic character:

1. Press the orange modifier key then .
A will display in the status bar to indicate that shift is on.
2. Press the character. The shift notifier in the status bar will turn off.

Example: Press ,  then  to type the capital letter Y.

To type all uppercase alphabetic characters:

1. Press the orange modifier key then .
A will display in the status bar to indicate that caps lock is on.
2. Press the character keys.
3. Press the orange modifier key and  again to turn caps lock off. The caps lock notifier in the status bar will turn off.

Example: Press ,  and then  to type the word COLD in all caps.

53-Key Keypad



The 53-key layout provides a Shift key and a Diamond key. The Diamond key provides a virtual keyboard with nine additional characters.

To type an alphabetic character or a number:

- Press the relevant character or number key.

To type a symbol or special character:

1. Press the blue modifier key.
2. Press the key for the symbol or special character.



Example: Press  and then  to type an asterisk.







To type a single uppercase alphabetic character:

1. Press .
A will display in the status bar to indicate that shift is on.
2. Press the character. The shift notifier in the status bar will turn off.

Example: Press  then  to type the capital letter Y.

To type all uppercase alphabetic characters:

1. Press  twice to turn the caps lock on.
A will display in the status bar to indicate that caps lock is on.
2. Press the character keys.
3. Press  again to turn caps lock off. The caps lock notifier in the status bar will turn off.



Example: Press   and then     to type the word COLD in all caps.

To type a single special character with the Diamond key:

To use the Diamond key, you must enable the virtual keyboard:

1. Swipe up from the bottom of the Home screen to access all apps.
2. Select **Settings > System > Keyboard > Physical keyboard**.
3. Enable **Use on-screen keyboard**.
4. Press . A nine-character matrix of special characters displays.
5. Tap a character.

To type multiple special characters with the Diamond key:

1. If you have not already, enable the virtual keyboard (see previous section.)
2. Double-tap  to lock the Diamond key on.
3. Tap the characters.
4. Press  again to hide the matrix.

Enter Characters on Numeric Keypads

Computer models with numeric keypads include orange and blue modifier keys for typing alphabetic characters and special characters as well as accessing functions. The keypads also have customizable auxiliary keys (F1 to F12) that when used in conjunction with the blue modifier key can provide up to 24 additional key functions.

To learn more about customizing the key functions, see [Remap a Button or Key](#) on page 38.

38-Key Keypad

To type a number:

- Press the relevant number key.

To type a single alphabetic character or symbol:

1. Press the orange or blue modifier key.
(If you press the orange key, **a** will display in the status bar to indicate that the keypad is in alphabetic mode.)
2. Press the key for the letter or special character.



Example: Press  and then  to type a lower case a.



To type multiple alphabetic characters:

1. Press the orange modifier key twice to lock it on.
a will display in the status bar.
2. Press the keys for the letters you want to input.
3. Press the orange modifier key once to return to typing numbers.

Example: Press   and then     to type the word “cold” in lower case letters.









To type a single uppercase alphabetic character:

1. Press the orange modifier key once.
a will display in the status bar.
2. Hold  while pressing the character key.
A will display in the status bar while you are holding  to indicate that shift is on.



Example: Press  then  +  to type the capital letter Y by itself.

Alternately, to type a single uppercase alphabetic character with the modifier key locked on:

1. Press the orange modifier key twice to lock it on.
2. Hold  while pressing the character key.

Example: Press   then  + . Release the  key and press    to complete the word “Cold”.

To type all uppercase characters:

1. Press the orange modifier key twice.
a will display in the status bar.
2. Press .
a will change to **A** in the status bar to indicate that caps lock is on.
3. Press the character keys.
4. Press  again to turn caps lock off. The caps lock notifier in the status bar will turn off.

Example: Press    then     to type the word “COLD” in all caps.



42-Key Keypad

To type a number:

- Press the relevant number key.







To type a single alphabetic character or symbol:

1. Press the orange or blue modifier key.
2. Press the key for the letter or special character.



Example: Press  and then  to type a lower case a.

To type multiple alphabetic characters:

1. Press the orange modifier key twice to lock it on.
2. Press the keys for the letters you want to input.
3. Press the orange modifier key once to return to typing numbers.



Example: Press   and then     to type the word “cold” in lower case letters.

To type a single uppercase alphabetic character:

1. Press  once.
 will display in the status bar to indicate that shift is on.
2. Press the orange modifier key once.
3. Press the character key. The shift notifier in the status bar will turn off.

Example: Press  then   to type the capital letter Y by itself.

To type all uppercase characters:

1. Press  twice rapidly to turn caps lock on.
 will display in the status bar to indicate that caps lock is on.
2. Press the orange modifier key twice to lock it on.
3. Press the keys for the letters you want to input.
4. Press the orange modifier then  to turn caps lock off. The caps lock notifier in the status bar will turn off.

Example: Press     then     to type the word “COLD” in all caps.

Enter Characters on the Large Numeric Keypad

Computer models with a large numeric 31-key keypad include orange and blue modifier keys for typing alphabetic characters and special characters as well as accessing functions. The keypad also has a programmable key  as well as customizable auxiliary keys (F1 to F6), which when used in conjunction with the blue modifier key can provide up to 12 additional key functions.





To learn more about customizing the key functions, see [Remap a Button or Key](#) on page 38.

To type a number:

- Press the relevant number key.

To type a single alphabetic character or symbol:

1. Press the orange or blue modifier key.
2. Press the key for the letter or special character one to four times in rapid succession depending on the position of the character illustrated on the key.

Example: Press  and then    to type a lower case c.

To type multiple alphabetic characters:







1. Press the orange modifier twice to lock it on.
2. Press the keys for the letters or special characters one to four times in rapid succession depending on the position of the character illustrated on the key.
3. Press the orange modifier key once to return to typing numbers.

Example: Press   and then

          to type the word “cold” in lower case letters.

To type a single uppercase alphabetic character:

1. Press the orange modifier key once.
2. Press .
A will display in the status bar to indicate that shift is on.
3. Press the orange modifier key again.
4. Press the key for the letter or special character one to four times in rapid succession depending on the position of the character illustrated on the key. The shift notifier in the status bar will turn off.

Example: Press    then    to type the capital letter Y.



Alternately, to type a single uppercase alphabetic character with the modifier key locked on:

1. Press the orange modifier key twice to lock it on.
2. Press .
3. Press the key for the letter or special character one to four times in rapid succession depending on the position of the character illustrated on the key.

Example: Press    then

          to type the word “Cold”.

To type all uppercase characters:

1. Press the orange modifier key twice to lock it on.
2. Press .
A will display in the status bar to indicate that caps lock is on.
3. Press the key for the letters or special characters one to four times in rapid succession depending on the position of the character illustrated on the key.
4. Press  again to turn caps lock off. The caps lock notifier in the status bar will turn off.



Example: Press    then

          to type the word “COLD” in all caps.

About the Audio Features



The CK67 has multiple speakers, a microphone, and several software tools to configure sound volume or enable vibration feedback.

Adjust Speaker Volume





The location of volume controls on CK67 Series computers differs between the keypad layouts (see [About the Keypad](#) on page 19). Volume up and down icons are printed in either blue or orange on the keypad overlay and are activated using the orange  or blue  modifier and the corresponding key.

Note: *The volume setting varies by OS version.*

To quickly change the active speaker volume level:



- Press the orange or blue modifier key followed by the corresponding key marked  to raise the volume of the active speaker.
- Press the orange or blue modifier key followed by the corresponding key marked  to lower the volume of the active speaker.

To access the volume quick set menu:

1. Press the orange or blue modifier key and either  or .
2. Adjust the volume level using the on-screen menu.
 - Tap the icon at the top to toggle the media volume between Sound On , Vibrate Only , or Silent .

- Use the slider to adjust the media volume.
- Select ●●● at the bottom to adjust Media, Call, Ring, Notification, or Alarm volume levels.

Enable Vibrate Mode

Press the required orange  or blue  modifier key depending on your model, then simultaneously press + and the **Power** button to quickly enable Vibrate mode so the computer vibrates instead of emitting sound for notifications and rings.

If you need quiet time without interruptions, enable Do Not Disturb to mute sound, stop vibration, and block notifications. Under the full settings menu, you can set a schedule for when you want Do Not Disturb to automatically turn on and off.

To enable Do Not Disturb manually:

1. Swipe down from the top of the screen to view the quick set menu.
2. Tap the **Do Not Disturb** icon  to toggle the feature On/Off.

Audio Settings

This section describes the audio and sound settings you can configure in the Settings app.

- To change audio settings, select the **Settings** app  and then tap **Sound & vibration**.

Note: *Sound settings are model dependent. Some settings may not be available for your model type.*

Sound Settings

Setting	Description
Media volume	Use the sliders to set the volume for media (e.g., music, videos, and games), calls, alarms, rings, and notifications.
Call volume	
Ring volume	
Notification volume	
Scanbeep Volume	
Alarm volume	
Do Not Disturb	Select to set which notifications to let through when you have Do Not Disturb turned on and when you want to be left alone.
Live Caption	<ul style="list-style-type: none"> • Turn the Use Live Caption feature on to automatically generate captions for media on your device. • Manage Live Caption options.

Setting	Description
Media	Select to show or hide media player when the media session has ended.
Vibrations & haptics	<ul style="list-style-type: none"> • Turn vibration and haptics on or off • Configure vibration for calls • Turn Notification and Alarm vibration on or off • Turn Touch feedback on or off • Turn Media vibration on or off
Shortcut to prevent ringing	Set what happens when you simultaneously press the Power and Volume up button. Options include: Vibrate, Mute, or turn the shortcut off.
Default notification sound	Select a notification sound.
Default alarm sound	Select an alarm sound.
Other sounds and Vibrations	Turn sounds on or off for: <ul style="list-style-type: none"> • Screen locking sounds • Charging sounds and vibration • Tap & click sounds • Always show icon when in vibrate mode

Insert a microSD Card

You can use a microSD card to increase file storage capacity or to install software. Honeywell recommends the use of Single Level Cell (SLC) industrial grade microSD or microSDHC memory cards with the computer for maximum performance and durability.

Note: *Format the memory card before initial use.*

1. Save your files and close any open applications.
2. Press and hold the **Power** button until the options menu appears.
3. Tap **Power off**.
4. If a hand strap is installed, release one end.
5. Remove the battery from the computer (see page 9).
6. Pull the tab on the microSD Card Door to remove it.

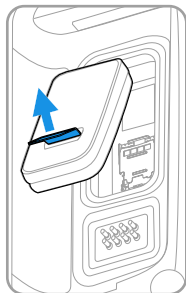

7. Press down gently and slide the card holder down. Lift the top of the holder down.

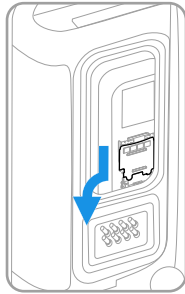

8. Insert the microSD card into the card holder with the contacts facing up.

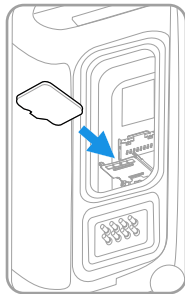

9. Close the holder with the card inserted. Press up gently on the card holder and slide it into the locked position.

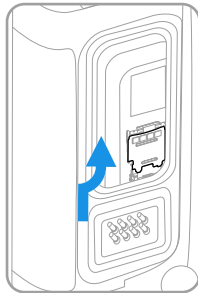

10. Reinstall the card access door.
11. Install the battery (see page [10](#)).
12. Install the hand strap (see page [14](#)).
13. Press the **Power** button to turn on the computer.

How to Transfer Files

To transfer files you need to physically connect the CK67 mobile computer to your workstation (e.g., laptop or desktop computer) through a USB connection. When the mobile computer is connected and USB is configured for file or photo transfer, use a file browser (e.g., File Explorer or Windows Explorer) on your

workstation to transfer files between the two computers. If you are transferring files to and from a Mac, use the Android File Transfer application (available from www.android.com/filetransfer).

Note: File transfer through a USB connection is disabled by default. You need to configure the USB connection for transferring files or photos.

You can use these accessories to connect your mobile computer to your workstation:

- Home Base or Ethernet Home Base and a standard USB Type B to A cable.
- A standard USB communication cable with Type C connector.
- CK3 Series USB cable (SKU 236-297-001).

Configure USB Connection and Transfer Files

Note: The CK67 supports Hi-Speed USB communications (USB 2.0) through the USB-C connector, with a maximum data transfer rate of 480 Mbps. USB on-the-go (OTG) is supported through the I/O connector.

1. Connect the CK67 to your workstation.
2. On the CK67, swipe down from the top of the screen to see the notifications.
3. Tap the **Android System** notification twice to open the options menu.
4. Select either **File Transfer** or **PTP**.
5. Open the file browser on your workstation.
6. Browse to the CK67. You can now copy, delete, or move files between the CK67 and your workstation.

Note: When Provisioning mode is disabled (turned off), some file folders are hidden from view in the file browser.

Accessories for the Computer

The CK67 ships with a hand strap and a battery. All other accessories are ordered and shipped separately. The computer requires a battery to function.

For a complete list of compatible accessories for the CK67 mobile computer series and their part numbers, see the CK67 Accessory catalog available for download from the CK67 product page at sps.honeywell.com.

Contact your local sales representative for ordering information.

CK67 Series Accessory	Part Number	Use With
Protective Boot	CK67-PB-1	CK67

The following legacy CK65/CK3 charging accessories are compatible with CK67 mobile computers:

CK65/CK3 Accessory	Part Number	Use With
CK65 Universal Charge Base Charges up to four devices.	CK65-CB-UVN	CK67 without boot
CK65 Universal Net Base Provides Ethernet connectivity and power for up to four devices.	CK65-NB-UVN	CK67 without boot
AD20 Single Dock Powers a device and charges a spare battery separately. Also provides client and host USB connectivity.	871-228-201, 871-228-301	CK67 without boot

User documentation for CK65/CK3 accessories is provided online at sps.honeywell.com.

ABOUT THE USER INTERFACE AND APPLICATIONS

Use this chapter to learn about the user interface and how to interact with the screen. You can also use this chapter to learn about the Honeywell applications on the computer.

Note: Screen content and features may vary by computer model and OS version.

About the User Interface

The Android operating system provides a touch-friendly and easy-to-navigate user interface. When you turn on the mobile computer, the Home screen is the first screen that appears after language provisioning and the startup Wizard is complete.

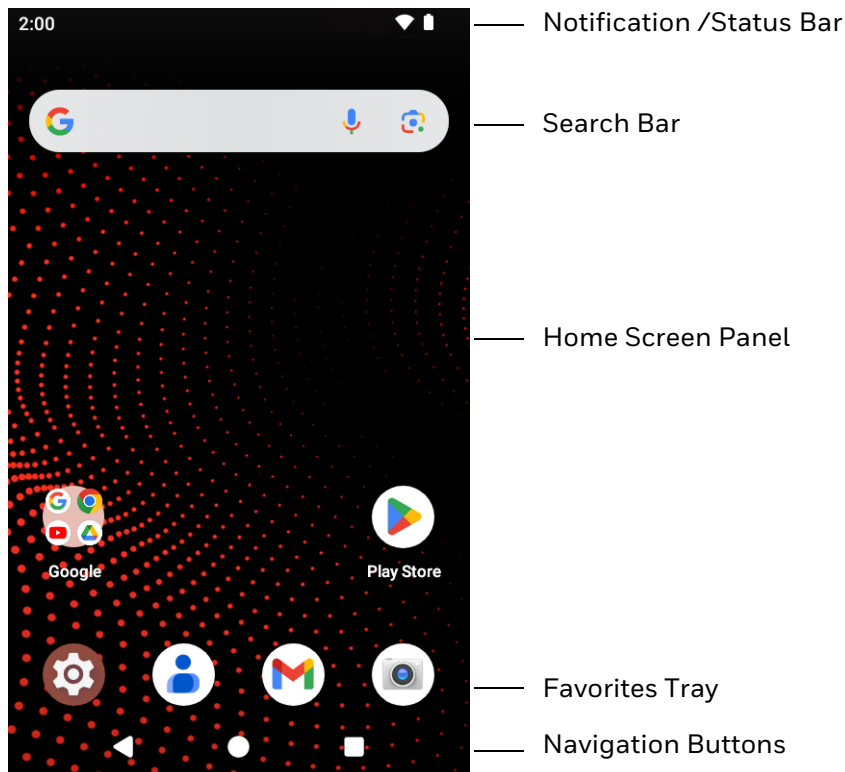

Home Screen Features











Item	Description
Notifications panel / Status bar	Status icons to the left tell you when an app has sent notifications, such as an arriving message. System icons to the right display the current wireless and network connection state and battery level.
Search bar	Search the Internet or the computer using Google. Touch the microphone icon in the search box to initiate a voice search or command.
Home Screen panel	You can create more than one custom Home screen panel. Swipe left or right on the Home to switch between your custom panels.
Favorites tray	App icons in the customizable tray are visible on all Home screen panels.

Navigation and Function Buttons

Your mobile computer has virtual buttons on the front panel below the Favorites tray and hardware buttons located on the sides for easy navigation and quick feature access when using the computer.

For button locations on the computer, see [Features of the CK67](#) on page 3.

Navigation and Function Buttons

Button	Description	
	Back	Return to the previous screen.
	Home	Return to the Home screen.
	Recent Apps	View and switch between recently used apps.
	Scan	Press the right, left, or front scan button to trigger the scanner.
	Orange Modifier Key	Access the characters, numbers, symbols, and functions marked in orange on the computer keys and keypad overlay (see page 21).
	Blue Modifier Key	Access the characters, numbers, symbols, and functions marked in blue on the computer keys and keypad overlay (see page 21).
	Function Key	Use the Key Remap feature in the Settings app to select a button function (see page 38).
	FldEx	Field exit (model dependent).
	Programmable Key	Default function is Headset Push to Talk (model dependent). Use the Key Remap feature in the Settings app to select a different button function (see page 38).
	Programmable Key	Use the Key Remap feature in the Settings app to select a button function (see page 38). (Model dependent.)

Button	Description	
	Programmable Key	Use the Key Remap feature in the Settings app to select a button function (see page 38). (Model dependent.)
	Left	Move left (model dependent).
	Right	Move right (model dependent).
	Up	Move up (model dependent).
	Down	Move down (model dependent).
	Diamond Key	Provides a virtual keyboard with nine additional characters (see 53-Key Keypad on page 22). (Model dependent.)
	Power	<p>Press and release the Power button to activate or exit Screen Timeout mode (see page 75).</p> <p>Press and hold the button for approximately 3 seconds and then release to view the options menu.</p> <ul style="list-style-type: none"> • Power off or Restart <p>Perform a manual restart if touchscreen is unresponsive (see page 109).</p>

About Status Bar Icons

Status and notification icons show you the current status of your network, the battery, notifications, and sounds. Use the table below to understand some of the most common icons.

Status and Notification Icons

Icon	Description	Icon	Description
	Pending alarm and Alarm is set		Airplane mode is turned on.
	New text message or multimedia message		Bluetooth is turned on.
	Error with text or multimedia message delivery		SD card is full
	New email		Wi-Fi network connected with full signal strength
	Computer is connected to a PC with a USB cable		Wi-Fi network connected but no signal strength
	Synchronizing data		Error with sync or sign-in
	Computer is connected with Ethernet		

Remap a Button or Key

You can change the default function of the Left Scan, Right Scan, or Camera buttons as well as the Back, Recent, Home, and Search virtual buttons.

1. Swipe up from the bottom of the Home screen to access all apps.
2. Tap **Settings**  > **Honeywell Settings** > **Keyremap**.
3. Tap the plus sign (+).
4. Press the button you want to remap or select one of the virtual buttons.
5. Tap **OK**.
6. Select one of the following options:
 - Tap **Keys** to view available functions. Select the function you want assigned to the button.
 - Tap **Apps** to view available applications. Select the application you want assigned to the button.
 - Tap **Actions** to enter an Intent or Broadcast. Tap **OK** to assign the action to the button. For example, to send a Broadcast, `android.intent.action.MASTER_CLEAR`, or to start an Intent, `com.android.settings/com.android.settings.wifi.WifiSettings`.
 - Tap **Command** to enter a command that will be executed when the button is pressed. This option supports all ADB shell commands. For example, if you choose a button to remap and enter the command “input keyevent 64”, pressing the selected button will open the web browser on the device.
 - Tap **Text** to type characters to display when the remapped key is pressed. Use a comma “,” to separate the characters. Tap **OK** to assign the text to the button. Examples are listed below:



Input Text	Button Press
A,A,B	aab
SHIFT_LEFT,A,SHIFT_LEFT,B or CAPS_LOCK,A,CAPS_LOCK,B	AB
SHIFT_LEFT,1	!
CTRL_LEFT,A	(Select All)
VOLUME_UP	(Volume Up)

Note: Lower case text is not supported in the **Text** field. Text must be entered in upper case. For example, “H,e,l,l,o” will display as “h”, whereas “H.E.L.L.O” will display as “hello”.

7. The function you selected now appears next to the button name.

Restore Default Button Action

To restore the button default action:

1. Swipe up from the bottom of the Home screen to access all apps.
 2. Tap **Settings**  > **Honeywell Settings** > **Keyremap**.
 3. Tap the clean icon .
 4. Choose the remapped button(s) you want restored to the default setting.
 - Tap the check box next to the button.
- OR
- Tap **All Select** to choose all the buttons.
5. Tap **Delete**.

View and Manage Notifications

You can view recent events on the computer, manage system notifications, change a setting, or quickly respond to an app notification by opening the notifications panel.

When a notification icon appears in the status bar at the top of the screen:

1. Swipe down from the top of the screen to open the notifications panel.
2. Respond to the notification. You can take one of the following actions:
 - Tap the notification to open the associated app.
 - Tap a quick-reply or action command (e.g., Reply, Archive), if available.
 - Swipe the notification sideways, off the screen to dismiss it.

Tap and hold the notification to reveal the settings icon .
Choose between **Default**, **Silent**, or **Turn off notifications**.

Note: Some notifications cannot be dismissed or turned off.

To close the notification panel, swipe up from the bottom of the screen, or tap the Back or Home buttons.

Open Quick Settings

Use the Quick Settings screen for easy access to common settings. Tap an icon to toggle the feature on/off or to open additional settings.

- To open Quick Settings, swipe down twice from the status bar at the top of the screen.
- To close Quick Settings, tap the Back or Home buttons.

Customize the Home Screen

You can add application icons to any Home screen for easier access.

1. Swipe up from the bottom of the Home screen to access all apps.
2. Tap and hold the app you want to add, and then start to drag the icon out of position. The computer then switches to a smaller view of the Home screen panels.
3. Drag and drop the app icon into place.
 - If you want to add another home screen, drag the icon to the right edge of the screen before releasing the icon.
 - If you want to create a folder, drag and drop the icon on top of another icon.

Note: *If you tap and hold an app but don't move it, a shortcut menu appears. The content of the menu depends on the app selected.*

To add widgets or customize the look of the Home screen:

1. Tap and hold an empty section of the screen.
2. Select either **Wallpaper & style**, **Widgets**, or **Home settings**.

Customize the Favorites Tray

Modify the Favorites tray to contain the apps you use the most.

1. Tap and hold the app icon you want to replace on the Favorites tray.
2. Drag and drop the app on “**X Remove**” at the top of the screen.
3. Swipe up from the bottom of the screen to access all apps.
4. Tap and hold the icon of the app you want to add.
5. Drag and drop the icon into position on the Favorites tray.

Use Google Search

Use the Google Search field to help you find anything you need on the computer or on the web.

1. On the Home screen, tap inside the Google Search box and begin to type your search term.

As you type, suggestions from Google web search appear below the Search box, and results from the computer (such as apps or contacts) appear below the web search results.

2. Tap a suggestion to search for it immediately, or touch the arrow to add the term to the search field without starting to search.

About Screen Gestures

Use your fingers to manipulate icons, buttons, menus, and other items on the screen.

- **Tap**

Tap to select something, toggle a setting on or off, or activate a field for text entry.

- **Tap and hold**

Tap and hold an item but do not lift your finger until an action occurs.

- **Drag and drop**

Tap and hold an item, and then slide your finger across the screen until you reach the target position. Lift your finger off the screen to drop the item in place.

- **Swipe**

Quickly move your finger across the screen, without pausing when you first touch. For example, you can swipe a Home screen left or right to view the other Home screens.

- **Slide**

Slowly move your finger across the screen, without pausing when you first touch. For example, you can slide a notification to the left until the Settings gear is revealed.

- **Double-tap**

Tap quickly twice on a web page, map, or other screen to zoom in. Double-tap again to zoom out.

- **Pinch**

In some apps, you can zoom in and out by placing two fingers on the screen at once and pinching them together (to zoom out) or spreading them apart (to zoom in).

Set the Time Zone

The computer gets the current date and time from its network connection. If preferred, you can change this behavior and manually set the time zone for your location.







1. Swipe up from the bottom of the Home screen to access all apps.
2. Tap **Settings**  > **System** > **Date & time**.
3. Tap **Set time automatically** to turn off the feature.
 - a. Tap **Date** then select a date from the calendar and click **OK**.







- b. Tap **Time** then use the clock to select a new time and click **OK**.
4. To change the time zone, tap **Set automatically** to turn off the feature.
 - a. Tap **Time zone** and choose the time zone for your location.

About Honeywell Applications

Honeywell applications help you troubleshoot and connect your computer to other devices and networks. Some of the applications in this table are located in the Power Tools app. To learn more about Honeywell Power Tools, go to sps.honeywell.com to download the *Power Tools User Guide*.

Honeywell Applications Available on the Computer

Icon	Application	Description
	AutoInstall Settings	Enable the AutoInstall feature, to automatically install *.zip or *.apk files containing applications saved in the Internal shared storage\honeywell\autoinstall folder and IPSM card\honeywell\autoinstall folder on the computer during the power-up boot or reboot process.
	Demos	Honeywell Demo apps demonstrate the basic capabilities of the computer and are not intended as functional business solutions. The demos included, demonstrate scanning, signature capture, NFC functionality, and printing via Bluetooth technology. Information on how to create custom applications for your Honeywell mobile computer can be found in the Honeywell Software Development Kit (SDK) for Android, available from the Technical Support Downloads Portal .
	HUpgrader	Use the Honeywell Upgrader app (HUpgrader) to automatically search for and install Over-the-Air (OTA) operating system updates from a remote server.
	RFID	Use the RFID Discovery app to pair a Honeywell mobile device with a Honeywell RFID reader.
	Scanner Edge	Use the Scanner Edge app to connect or disconnect a Bluetooth scanner. <ul style="list-style-type: none"> • View connected devices. • Pair with a Bluetooth Scanner. • Disconnect a Bluetooth Scanner.
	Staging Hub Agent	View information related to the Op Intel agent. For more information on Operational Intelligence, go to sps.honeywell.com .
Power Tools		
	BattMon	BattMon provides information on the charge status and health of the battery, and provides access to activate battery status notifications and battery charging history logs.

Icon	Application	Description
	ConfigApps	ConfigApps enables or disables applications and application updates.
	Configure Autorun	Configure Autorun provides the ability to set applications to automatically run after a reboot.
	Diagnostic Information	Diagnostic Information provides access to system statistics, notifications, and version information about the computer.
	EZConfig	EZConfig supports advanced customization and configuration of the handheld computer. EZConfig includes a standard XML editor and configuration barcode scanner feature.
	WiFi Diagnostic	Use application to: <ul style="list-style-type: none"> View Wi-Fi radio status information about a connected access point or a list of other available access points in range of the Wi-Fi radio. Use the Route utility to view packet destination gateway information across the subnets. Use the IPConfig utility to view IP parameters for the on-board network adapters. Use the Ping utility to verify communication links or to make sure a specific IP address is working.
	Wireless Tether	Use to enable range tracking and customize out-of-range alerts for Bluetooth devices paired and tethered to your handheld computer.

Applications You Can Download to the Mobile Computer

You can download Honeywell applications to extend the capabilities of the computer. You may need to purchase a license to run some applications. To learn more about the applications described in this section and other Honeywell software solutions, go to sps.honeywell.com and click **Software > Productivity**.

About Honeywell Enterprise Browser

Honeywell Enterprise Browser is a locked-down enterprise Web client application designed for Honeywell computers. It provides a controlled Web application environment that helps enterprises increase productivity and reduce IT management expenses. You can configure Enterprise Browser for your specific application requirements and design custom web applications that run through the Enterprise Browser to provide your users with an easy-to-use yet controlled experience.

If Enterprise Browser is not included on your computer model, you can download a trial version for evaluation. After the evaluation period expires, you need to purchase a license. For more information about Enterprise Browser, visit sps.honeywell.com.

About Honeywell Launcher

Launcher is a configurable locked-down menu program designed for Honeywell computers that prevents end-users from accessing the start menu and other non-authorized applications. Use Launcher to provide a platform where your mobile computer users are limited to running only company-approved applications and prevent them from initiating unauthorized configuration changes. You can also use Honeywell Launcher together with Honeywell Enterprise Browser to create a single-purpose device configuration.

If Launcher is not included on your computer model, you can download a trial version of the software for evaluation. After the evaluation period expires, you need to purchase a license. For more information about Launcher, visit sps.honeywell.com.

About Terminal Emulators

Honeywell offers several terminal emulator solutions that allow users to manage their mobile devices by providing reliable data transfer between the host mobile device and terminal. Terminal emulators can be used for remote management and configuration of devices, data collection and analysis, and session management.

Depending on the computer model, a terminal emulator may come preinstalled on the device. If a terminal emulator is not included on your model, you can download a trial version for evaluation. After the evaluation period expires, you need to purchase a license. For more information, visit sps.honeywell.com.



About UEMConnect

Honeywell UEMConnect enables customers to use the Google OEMConfig protocol to perform enterprise configuration and enhance the management of Honeywell Mobility Edge devices. It seamlessly integrates with EMM solutions to expose Honeywell management extensions directly on the EMM console. UEMConnect provides exclusive access to hundreds of advanced Honeywell proprietary settings and provides supplemental access to standard EMM features. EMM providers may also make use of generic Android APIs to provide standard EMM functionality.

Honeywell UEMConnect is available for download in the Google Play™ store. UEMConnect licenses are included with the purchase of applicable SOTI offerings through Honeywell or may be purchased separately for applicable EMM solutions not purchased through Honeywell.

Unlock Developer Options

Developer options only appear in the Settings app if you unlock the feature. If you are a developer working with the computer, you can easily unlock the additional settings to use for testing and debugging applications under development for the computer.

1. Swipe up from the bottom of the Home screen to access all apps.
2. Tap **Settings**  > **About phone**.
3. Tap **Build number** seven times. A message appears informing you that you are now a developer.
4. Tap **Developer options** under **Settings**  > **System**.

USE THE IMAGER

Use this chapter to understand how to scan barcodes, configure the scan settings, and capture images using the integrated image engine in the computer.

About the Image Engine

You can use the imager in the computer as a scanner or camera.

- Use the imager as a scanner to read 1D and 2D barcode symbologies, composite symbologies, and postal codes. It also supports omni-directional scanning for greater flexibility in real-world settings. By default, the scanner feature is enabled and uses the default scan profile. You can modify the **Default Profile** or create new profiles for custom applications from the **Settings > Honeywell Settings > Scanning**.
- Use the imager as a camera to capture black and white images, such as signatures or pictures of damaged inventory. The imager camera feature requires the development of a custom application that uses the Honeywell Mobility SDK for Android. To download the Honeywell Mobility SDK for Android, see [Developer Information](#) on page 93.

Note: *Instead of using the internal imager, you can also use Bluetooth communications to connect the computer to an external scanner, such as the Granit™ 1981i and 1911i.*

About the Scan Wedge Feature

The scan wedge feature sends scanned barcode data to an active application as Android keypad input. To scan a barcode as keyboard input, open an application that accepts text input and then scan a barcode. You can use applications that are coded to use the scanner or applications that receive data through the scan wedge feature. If an application claims the scanner through the BarcodeReader API, the scan wedge feature is temporarily disabled.

You can find information on how to create custom applications for the computer in the *Software Development Kit (SDK)* available for download from the *Technical Support Downloads Portal* at honeywell.com/PSSsoftware-downloads. Once you create an account and enter the portal, navigate to **Software > Software and Tools > Developer Library > SDKs for Android**.

Change the Scanner Settings

Changes you make to the Default profile apply to all applications with no profile assigned.

1. Swipe up from the bottom of the Home screen to access all apps.
2. Tap **Settings**  > **Honeywell Settings** > **Scanning**.
3. Tap **Internal Scanner** > **Default profile**.
4. Select from the following:
 - **Data Processing Settings**
 - **Symbology Settings**
 - **Decode Settings**
 - **Imager Settings**
 - **Trigger Settings**
 - **Notification Settings**
 - **OCR Settings (see page 58)**
5. Modify the settings to meet your application needs.

To learn more about the scanner settings, [Default Scan Settings](#) on page 49.

Restore Default Scan Settings

You can easily discard all changes you made to the Default profile and restore the default values.

Note: *When you choose the Restore all defaults option from any of the settings screens in a profile, all the settings in that profile return to their default values.*

1. Open the **Default profile**.
2. Tap  in the upper right corner of any of the scan settings screens for the profile.
3. Tap **Restore all defaults**.

Default Scan Settings

Use the following sections to understand the scan settings available for scanner profiles. To learn how to create a new profile, see page 55.

Data Processing Settings

Use the Data Processing Settings to specify how barcode data is processed by the computer.

Data Processing Settings

Setting	Description	Default										
Wedge	Enable or Disable the scan wedge feature.	Enabled										
Wedge Method	Standard or Keyboard.	Standard										
Charset	Select the character set to use when interpreting the barcode data into a string.	ISO-8859-1										
Prefix	<p>Defines the string added before the decoded barcode data. Substitutions occur within the Prefix string values.</p> <table border="1"> <thead> <tr> <th>Substring</th> <th>Replacement Character Code</th> </tr> </thead> <tbody> <tr> <td>\r</td> <td>13</td> </tr> <tr> <td>\n</td> <td>10</td> </tr> <tr> <td>\t</td> <td>9</td> </tr> <tr> <td>\\</td> <td>'\'</td> </tr> </tbody> </table>	Substring	Replacement Character Code	\r	13	\n	10	\t	9	\\	'\'	None
Substring	Replacement Character Code											
\r	13											
\n	10											
\t	9											
\\	'\'											
Suffix	<p>Defines the string added after the decoded barcode data. Substitutions occur within the Suffix string values.</p> <table border="1"> <thead> <tr> <th>Substring</th> <th>Replacement Character Code</th> </tr> </thead> <tbody> <tr> <td>\r</td> <td>13</td> </tr> <tr> <td>\n</td> <td>10</td> </tr> <tr> <td>\t</td> <td>9</td> </tr> <tr> <td>\\</td> <td>'\'</td> </tr> </tbody> </table>	Substring	Replacement Character Code	\r	13	\n	10	\t	9	\\	'\'	None
Substring	Replacement Character Code											
\r	13											
\n	10											
\t	9											
\\	'\'											
Wedge as keys	List of character values to wedge as keys, represented as a comma-separated list of decimal values.	9,10,13										
Data Editing Plugin	Specify a data editing plug-in and edit plug-in settings.	None										
Symbology Prefix	<p>Specify a symbology identifier prefix to the barcode data. Options include:</p> <ul style="list-style-type: none"> None Honeywell AIM 	None										

Setting	Description	Default
Launch Browser	<p>Enable or disable URL barcode handling. If a barcode starts with http:// or https://, the browser opens using the barcode data as a URL.</p> <p>Corresponds to BarcodeReader property: PROPERTY_DATA_PROCESSOR_LAUNCH-BROWSER</p>	Disabled
Scan to intent	<p>Enable or disable special handling of scan-to-intent barcodes.</p> <p>Applies to barcodes in one of the following formats: '//' ACTION '//' ACTION '\$' extra-data</p> <p>Where: ACTION and extra-data are any string of characters.</p> <p>Launches an application listening for the intent. Intent action: "com.honeywell.scantointent.intent.action." + ACTION Intent extra: "com.honeywell.scantointent.intent.extra.DATA" contains the remainder of the barcode data after the first '\$' character.</p> <p>Corresponds to BarcodeReader property: PROPERTY_DATA_PROCESSOR_SCAN_TO_INTENT</p>	Enabled
Launch EZ Config	<p>Enable or disable special handling of EZConfig barcodes.</p> <p>Applies to EZConfig barcodes that are encoded with the Aztec symbology and contain specific header data.</p> <p>Corresponds to BarcodeReader property: PROPERTY_DATA_PROCESSOR_LAUNCH_EZ_CONFIG</p>	Disabled
Data Intent	<p>Enables the reception and processing of barcode data without using an SDK or library.</p>	Disabled

Symbology Settings

Use the Symbology Settings to enable or disable barcode symbologies for the selected scan setting profile.

- Tap the check box next to a symbology name to enable (check mark) or disable (no check mark) decoding for that symbology.
- Tap the symbology name to view and modify additional configuration parameters for the symbology selected.

To view a list of default settings for supported symbologies, see [page 114](#).

Decode Settings

Adjust the Decode Settings when scanning barcodes that are densely packed or poor quality.

Decode Settings

Setting	Description	Default
Center Decode	<p>When enabled, the imager scans and decodes a barcode only if part of the barcode is at the center of the aimer window. This is useful in situations where several barcodes may be very close together in the imager field-of-view.</p> <ul style="list-style-type: none"> • Tap the check box to toggle the feature on or off. • Select Center Decode to adjust the Center Decode Timeout and the Window dimensions. <p>Honeywell recommends leaving the settings at 50 (default) to define the “center” area for the barcode.</p> <p>Configurable parameters:</p> <ul style="list-style-type: none"> • Center Decode Timeout (ms) • Window top • Window bottom • Window left • Window right • Aimer Finder • Aimer Finder Timeout 	Disabled
Decode Security	Use this setting to control the reading tolerance of the decoder. Lower settings are more lenient when reading low quality barcodes while higher values are more strict.	2
Decoder timeout	Set the amount of time in seconds that the scanner will timeout if a readable barcode is not found.	150
Decode Filter	<p>Use this setting to modify or reject data strings.</p> <ul style="list-style-type: none"> • Decode filter script The decode filter script is used to configure a filter for decode results during scanning. For example, a filter could be used to reject barcodes that don't begin with certain characters, remove leading characters (like “00”) from the beginning of a barcode, or only scan barcodes that begin with certain characters. • Decode filter timeout (ms) The decode filter timeout option can be used to disable the logic inside the filter script after a given amount of time. • Debug level Set the filter information level. The default level is 0, no information. Higher levels emit more information. Level 4 emits the most information. 	None
Poor Quality 1D Reading	Enable this setting when scanning damaged or badly printed 1-D barcodes to improve barcode read success.	Disabled

Setting	Description	Default
Video mode	<p>Use this setting to specify whether normal or inverse decoding for linear symbologies is enabled during the execution of Decode. By default normal video is enabled.</p> <p>Options include:</p> <ul style="list-style-type: none"> • Normal • Inverse • Normal and Inverse 	Normal
DPM mode (license required)	<p>Use this setting when scanning Direct Part Marking (DPM) barcodes that are etched or imprinted directly into the surfaces of materials including metal and plastic.</p> <p>Options include:</p> <ul style="list-style-type: none"> • No DPM optimization • Dotpeen DPM decoding • Reflective DPM decoding 	No DPM optimization
Region of Interest	<p>Set the ROI for decoding. Options include:</p> <ul style="list-style-type: none"> • Disable ROI is disabled and the entire original image is sent to the decoder. • Standard Use the aimer position to weight activity. Activity calculated on the row and the column in the middle of each cell. The ROI window may not include the aimer. • Standard, aimer centered Activity calculated on the row and the column in the middle of each cell. The ROI window will always include the aimer. • DPM, aimer centered Activity calculated on 4 rows and 2 columns in each cell. The ROI window will always include the aimer. • Kiosk/presentation application Ignore aimer position, no weight activity. Activity calculated on the row and the column in the middle of each cell. The ROI window may not include the aimer. • Learning Engine When selected, the computer will receive continuous updates to improve the decoder software based on your specific environment. The Staging Hub Agent must also be enabled. • Smart Detection Measures image gradients and clusters regions with high gradients. ROIs are prioritized based on their gradient magnitudes and densities. 	Disabled
Image Binning	<p>Enable internal binning of the image to decrease the average decode time. When the setting is enabled, the decoder will bin every 2x2 area in the image.</p>	Disabled

Setting	Description	Default
Multicode Scan	<p>When you enable Multicode Scan, each barcode is checked to see whether it satisfies the defined multicode rules before the results are transmitted. Options include:</p> <ul style="list-style-type: none"> • Enable or disable multicode scanning. • Set the number of barcodes. • Specify a separator to be used between barcodes. • Define up to 10 barcodes to be included in the multicode. • Set a timeout in milliseconds. If set with a non-zero value, the timeout starts after the scan button is pressed. Once the timeout occurs, scanning will return to standard (single) barcode mode. • Enable or disable the transmission of an incomplete multicode. When enabled, the incomplete multicode is transmitted when the incomplete transmission timeout expires. • Set a timeout in milliseconds to use when incomplete transmission is enabled. If set with a non-zero value, the timeout starts after the scan button is pressed. Once the timeout occurs, the results that were collected before the timeout happened will be transmitted if they satisfy the defined multicode rules. 	Disabled
Preferred Symbology Settings	<p>Set the priority level (High or Low) for symbology codes. This is used when you want to specify one symbology as a higher priority over other symbologies in situations where both barcode symbologies appear on the same label, but the lower priority symbology cannot be disabled. If a code is set as a High Priority, the decode of that symbology is accepted immediately. If a code is set as a Low Priority, the decode is buffered to see if a decode of a preferred High Priority symbology can be found within a given timeout period.</p> <p>To apply Preferred Symbology Settings, tap the check box. Preferred Timeout (ms) - The amount of time milliseconds that will allow the scanner to search for a High Priority barcode after a Low Priority barcode has been encountered. The default is 500ms.</p> <p>To set the priority level for a symbology, tap the code in the list then select the priority. The default for all codes is "High Priority."</p>	Disabled
Fast Linear Decode	Enable the Fast Linear Decoder to accelerate decoding of well-printed 1D barcodes.	Disabled
GS1 Digital Link Conversion	Converts GS1 Digital Link Codes from web URI syntax to traditional GS1 element string syntax.	Disabled

Imager Settings

You should not need to modify the Imager Settings. The **Override Recommended Values** setting is disabled by default. The recommended Imager Settings are designed to work in a wide range of environments and should only be modified if you have an advanced understanding of imagers.

Trigger Settings

Use the Trigger Settings to configure how the scan buttons work.

Trigger Settings

Setting	Description	Default
Enable Scan Trigger	Enable or Disable activating the imager by pressing the side scan buttons or the virtual Scan button in the Scan Demo app.	Enabled
Scan delay	Set the minimum amount of time in seconds before the scanner can read another barcode.	0
Decode timeout	Set the number of seconds before the scanner automatically turns off if the scan button is pressed and nothing has successfully decoded.	20
Trigger Scan Mode	Set read behavior on scan button press. Options available: <ul style="list-style-type: none"> • One Shot • Continuous • Read on release • Read on second trigger press 	One Shot
Presentation Mode	<p>Presentation Mode uses ambient light and scanner illumination to detect barcodes. When in Presentation Mode, the LEDs remain dim until a barcode is presented to the scanner, then the aimer turns on and the LEDs turn up to read the code. If the light level in the room is not high enough, Presentation Mode may not work properly.</p> <p>Click on Presentation Mode to access available options:</p> <ul style="list-style-type: none"> • Enable Presentation Mode • Active Phaser Aimer On • Idle Phase Illumination On • Idle Phase Illumination Intensity • Active Phase Illumination Period 	Disabled
Same symbol timeout	Set the minimum buffer time in seconds before the scanner reads the same barcode. This can be adjusted to prevent inadvertent scans of the same barcode if the code is left in the scan field longer than the Decode Timeout limit. The default same symbol timeout is 1000 seconds.	Disabled

Notification Settings

Use the Notification Settings to configure how your computer responds when you scan a barcode.



Notification Settings

Setting	Description	Default
Good Read Notification	Enables or disables a good read notification. The notification consists of a green blink of the Scan Status LED, a short beep, and an optional short vibration.	Enabled

Setting	Description	Default
Good Read Notification File	Use the default notification sound for a good read or specify an audio file to use instead.	Default Sound
Bad Read Notification	Enables or disables notification of a failed scan. The notification consists of a red blink of the Scan Status LED, an error beep, and an optional short vibration.	Disabled
Vibrate On Notification	Enables or disables whether the computer vibrates when there is a good or bad read.	Disabled
Vibrate Duration	When Vibrate On Notification is enabled, sets the length of the vibration in microseconds.	100

Add a Scan Setting Profile

To create a scan setting profile for a custom app on the computer:

1. Swipe up from the bottom of the Home screen to access all apps.
2. Tap **Settings**  > **Honeywell Settings** > **Scanning** > **Internal Scanner**.
3. Tap  in the upper right corner of the app screen.
4. Take one of the following actions:
 - Tap the profile name field. Add a new name, and then select **OK**.

OR

 - Tap the **select an application** option, and then choose an app from the list.

The new profile appears on the Internal Scanner profile list. You can now select and modify the scan settings for the new profile.

Delete a Scan Setting Profile

1. Swipe up from the bottom of the Home screen to access all apps.
2. Tap **Settings**  > **Honeywell Settings** > **Scanning** > **Internal Scanner**.
3. Tap and hold the profile you want to delete.
4. Tap **Delete**, and then **OK**.

Change the Bluetooth Scanner Settings

When a Bluetooth scanner is paired, changes can be made to the Default profile for the scanner.

1. Swipe up from the bottom of the Home screen to access all apps.
2. Tap **Settings**  > **Honeywell Settings** > **Scanning**.

3. Tap **Bluetooth Scanner > Default Profile > Data Processing Settings**.
4. Modify the settings to meet your application needs.

To learn more about the scanner settings, see [Data Processing Settings](#) on page 49.

About the Optional Digital Scan Button

By default, the imager is enabled for scanning with the left, right, and front scan buttons configured to trigger the imager. If your application environment requires use of an on-screen scan button, enable the Digital Scan Button feature in the Settings app. Once enabled, you can then modify the appearance of the on-screen Scan button and select the apps the button appears in.

Enable and Configure the Digital Scan Button

1. Swipe up from the bottom of the Home screen to access all apps.
2. Tap **Settings**  > **Honeywell Settings > Digital Scan Button**.
3. Tap **Enable Digital Scan Button** to turn the feature on. A preview of the button appears at the bottom of the screen.
4. Configure the button appearance. As you adjust the settings, the preview button updates.
 - Tap **Select Button Size** and then choose Small, Medium, or Large.
 - Tap **Select Button Color** and then choose from seven color options. Default color is black. Tap a dot to select the color, and then select **OK** to confirm.
 - Use the slider under **Set Transparency Level** to adjust how transparent the button appears on the application screen.
5. Drag the preview of the scan button to the location where you want it to appear on the screen. Once you have positioned the button, select the **Set Button Location** toggle button to lock it into position.
6. Tap **Choose Application**.
7. Check the box next to all the applications where you want the digital scan button to be available.
8. Select **OK**.
9. Tap **Back** to return to the Settings screen.

The digital scan button appears on the screen when you open any of the apps you selected during the button setup. Tap and hold the button to activate the imager and scan a barcode.

Scan Barcodes

By default, the computer imager is enabled for scanning. It supports omni-directional (360°) barcode scanning and an aiming beam is provided to help assist with targeting barcodes.

Before you start scanning barcodes, go into **Settings > Honeywell Settings > Scanning > Internal Scanner** and modify the scan profile to enable only the barcode symbologies that you need. By reducing the active symbology list, you can increase scan speed.

1. Point the scanner window at the barcode. For optimum performance, avoid reflections by scanning the barcode at a slight angle.
2. Press and hold any **Scan** button (i.e., right, left, or front).
3. Center the aiming beam over the barcode. Make sure the entire barcode is inside the illumination frame.

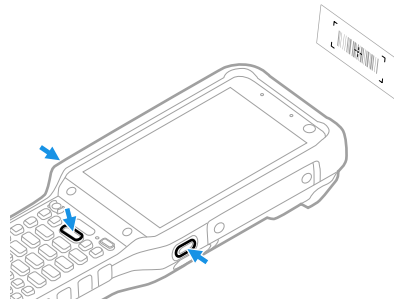

4. Release the Scan button when the computer beeps, and the Scan Status LED briefly turns on. The barcode information is entered into the application in use.

Note: *Not all barcode symbologies are enabled by default. If a barcode does not scan, the correct symbology may not be enabled.*

About Scanning Configuration Barcodes

After completing the out-of-box set up process, Provisioning mode is automatically turned Off. Scanning a barcode to install applications, certificates, configuration files, and licenses on the computer is restricted unless you turn On (enable) Provisioning mode in the Settings app.

To learn more [About Provisioning Mode](#) see [page 93](#).

Use the Scan Demo App

Use the Scan Demo app to read barcodes or to test your symbology decode settings.

1. Swipe up from the bottom of the Home screen to access all apps.
2. Tap the **Demos** app.

3. Swipe left or right on the screen until **Scan Demo** appears under the turntable. Tap the center of the box image to open the app.
4. Point the scanner window at the barcode.
5. Press and hold any **Scan** button (i.e., right, left, or front) or tap and hold the on-screen **Scan** button.
6. Center the aiming beam over the barcode. Make sure the entire barcode is inside the illumination frame.

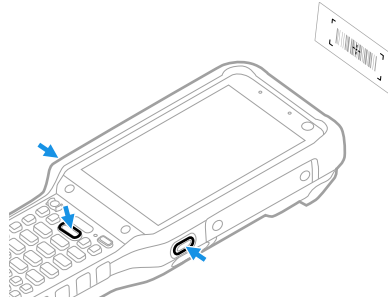

7. Release the Scan button when the computer beeps, and the Scan Status LED briefly turns on. barcode information appears on the screen.

Note: *In the Scan Demo app, not all barcode symbologies are enabled by default. If a barcode does not scan, the correct symbology may not be enabled.*

Change the Scan Demo Symbology Settings

1. In the Scan Demo app, tap  in the upper right corner of the screen.
2. Select **Symbology Settings**.
3. Modify the symbology parameters.
 - Tap the check box next to a symbology name to enable (check mark) or disable (no check mark) decoding for that symbology.
 - Tap the symbology name to view and modify additional configuration parameters for the symbology selected.
4. Tap **Back** to return to the Scan Demo app.

Smart OCR

Honeywell mobile computers with supported image engines can use Smart OCR (Optical Character Recognition) to scan text using the imager on the computer.

Enable Smart OCR

To perform OCR operations, the OCR wedge must be enabled. When the OCR wedge is disabled, the mobile computer will only perform barcode scanning.

Note: Devices that support Smart OCR will be released with a 60-day trial license. A license is required to use the Smart OCR function beyond the 60-day trial. If no license exists for Smart OCR, the OCR Settings menu option will not be displayed. Contact a Honeywell representative for licensing information.

1. Swipe up from the bottom of the Home screen to access all apps.
2. Tap **Settings > Honeywell Settings > Scanning**.
3. Tap **Internal Scanner > Default profile**.
4. Tap **OCR Settings**.
5. Tap **Enable OCR**.

After the OCR wedge is enabled, tapping the OCR Settings menu option will display the OCR Settings screen.

OCR Settings

The OCR Settings screen has two tabs:

- OCR Settings - Define the Smart OCR settings.
- Result Regex - Apply regular expressions (regex) to filter and refine the scan results.

OCR Settings Options

The following options are available on the OCR Settings tab.

Setting	Description	Default
Enable OCR Wedge	Turn the OCR wedge on or off.	Disabled
Sound Mode	Choose when a notification sound will be played for an OCR scan.	Sound after decode
OCR Exclusive	When this setting is enabled, the scanner will only decode the OCR text and not decode the normal barcode.	Disabled
Result String Model	Sets whether the device will capture the image in a block or line. <ul style="list-style-type: none">• Block - The device will capture the whole picture from the scanner and process all of the data in it.• Line - The device will only take one line of text as a character string to process the result.	Line

Setting	Description	Default
Single Result	Determines if the device will wedge one result or multiple results. <ul style="list-style-type: none"> Enabled - Only one result will wedge. Disabled and Result String Mode is "Line" - A pop-up will be displayed with all results captured from scanning. The user must select the results to use. If the user does not select any results, the scan operation will dismiss after 20 seconds. 	Enabled
Scan Window Size	Sets the size of the scanning capture area to Small, Medium, or Large. A larger scan window captures a larger area when doing OCR, but the scan will be slower and not as accurate.	Medium
Scan Window Type	Sets the shape of the scanning capture area to Rectangle (for long lines of text) or Square (for blocks of text).	Rectangle
Flip the image	Sets how the captured image will be flipped before being sent to OCR. <ul style="list-style-type: none"> None (not flipped) Vertical Flip Horizontal Flip 	None
Redundancy Count	Sets the number of times a scan result is decoded before wedge out, which may reduce the number of errors. Note that the higher the redundancy count, the longer it will take to decode.	1
Create Shortcut	Adds a shortcut to Smart OCR on the home screen. If the shortcut was created by default or the shortcut has previously been added from this menu, the Create Shortcut menu item will not be displayed.	

Result Regex

The Result Regex tab contains regex (regular expression) templates to quickly pick up or filter the required data from all the scanned OCR results. You can also create custom regex as needed to refine your results.

If any scanned data matches the selected pattern, it will show in the result. When no regex are applied, all data formats are accepted.

By default this tab will list all the available regex with none selected. To apply a regex, select the check box.

Embedded Regex

Name	Regex Pattern	Example
Packaging/Shipping Form	<code>^([0-9]{7}M*)((([0-9]{4}-[0-9]{5}-[0-9]{6}) ([0-9]{1,2}/[0-9]{1,2}/(?:\d{2}){1,2}) ([0-9]{1,}0{2,}) ([0-9]{1,})\$</code>	<ul style="list-style-type: none"> PO number: 2249154 0048601M 7000-40021-0140300 Quantity: 1.00 25 Date: 3/19/2021 11/25/21
Pure Number	<code>^[0-9.,-]*M*\$</code>	6901M2.85 9M9-1219
Telephone Number	<code>d{3}-d{8} d{4}-d{7}</code>	258-14547846 9697-4578989
Mobile Phone Number	<code>1[0-9]{10}</code>	15845414789
Pure Letters	<code>^[A-Za-z]+\$</code>	fhghlflAskIzRshgWQRQ
Number and Letters	<code>^[A-Za-z0-9]+\$</code>	Fhgh789lflA456skIzRshgW97QRQ
Postcode	<code>[1-9]d{5}(?!d)</code>	215000
IP Address	<code>d+.d+.d+.d+</code>	192.168.1.1 456.4547.454.1548

Add Custom Regex

In addition to the regex that are embedded in the app, you can create custom expressions to refine scanning results and improve accuracy. Smart OCR uses standard regex expressions and formatting (i.e., ^, ., \$, { }, etc.).

To add a regex:

1. With the Result Regex tab selected, tap the plus sign.
2. In the Regex field, enter the expression.
To make entering an expression easier, the app provides Regex Easy Select options with commonly used formats. Select the Numbers, Letters, or Date tab then tap the item you want to use. The code is added to the Regex line. You can use this code as it appears or modify it based on your need.

The app verifies that the regex is valid. If it is not, an error message is displayed. An invalid expression cannot be saved.

3. Enter a Name for the expression. The Name cannot be used by another expression.

4. On the Test line, enter characters that you would expect to match the Regex. The app checks if the regex matches the string. Matching characters are shown in green, and the word “Matched” is displayed if the string matches the regex.

In this example, the Regex looks for six consecutive numbers. The letters and extra numbers will be filtered out of the result. The Test field shows what matches the Regex.

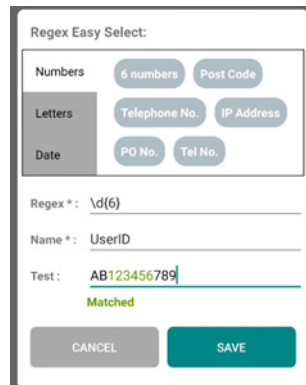

5. Tap the **SAVE** button. The app validates that the Regex and Name are valid. If not, an error message is displayed.
6. When the regex is saved successfully, it will appear in the Result Regex list. By default, a custom regex is selected when you create it. Uncheck the box to deselect the expression.

A custom regex displays the information icon: .

View or Edit Custom Regex

For a custom regex, you can view and edit the expression and name.

Note: You cannot view or edit details for embedded regex. See [Result Regex](#) for the patterns in embedded expressions.

1. On the Result Regex tab, tap the information icon for the regex.
2. Edit the Regex as required.
3. Edit the name as required.
4. Tap **SAVE** to record the changes.

Delete Custom Regex

1. On the Result Regex tab, tap the information icon for the regex.
2. Tap **DELETE**.
3. On the pop-up window, tap **CONFIRMED**.

Sequence Regex

By default, the **Sequence Regex** setting is disabled. The selected regex are combined with “OR” logic, and the app checks if a character string matches any of the selected expressions, so a candidate would be considered a match if it met the criteria of regex1 OR regex2 OR regex3.

When **Sequence Regex** is enabled, the scan will pick up the character string matched as regex with one regex item for one string.

The following examples would return matches if the character strings match the regex in any order:

String1 matches regex1

String2 matches regex2

String3 matches regex3

Or

String1 matches regex2

String2 matches regex3

String3 matches regex1

Note: **Single Result** must be disabled for multiple outputs.

Results will be returned in the order they match the regex.

Results in Order

To only return results that match the order of the regex, select **Results in Order**. When this is selected, regex are applied in the order they are listed on the Result Regex tab. To change the regex order, hold and drag the heading to the desired location in the list.

When Results in Order is enabled, the character strings must be in the same order as the regex items, or no result will be returned.

For example, the result will be recognized if:

String1 matches regex1

String2 matches regex2

String3 matches regex3

The following order would not be recognized:

String1 matches regex1

String3 matches regex3

String2 matches regex2

For better results with multiple outputs, go to **Settings > Honeywell Settings > Scanning > Internal Scanner > Default profile > Data Processing Settings** and set the value of **Suffix** to “\n”.

Regex Results

The following table shows how results are returned based on which settings are enabled.

Options Selected	Results
Regex selected Sequence Regex not enabled	Results are returned in the order they are matched. Changing the order of the regex does not affect the result.
Sequence Regex enabled	Results are returned in the order of the regex.
Sequence Regex and Results in Order enabled	Results are returned in the order of the regex. Regex order must be in the same order as the character strings in the scanned image. If the orders are different, no results will be returned.

Deploy OCR Settings with EZConfig

EZConfig can be used to export Smart OCR settings to install the same configuration on other mobile devices using the Datacollectionsservice.xml file.

1. Tap **Settings > Honeywell Settings > Provisioning Mode** and turn Provisioning Mode On.
2. Swipe up to select all apps and select **Power Tools**.
3. Tap **EZConfig**.
4. Tap the three bars menu then tap **Generator**.
5. EZConfig generates Datacollectionsservice.xml in the following location: Internal Storage/Honeywell/EZconfig/generated/ folder.

Use one of these options to deploy the settings to another device:

- Copy the Datacollectionsservice.xml file to the device in the Internal Storage/Honeywell/persist folder. Reboot the device to apply the settings.
- Use the EZConfig editor on your PC to create a configuration barcode that can be scanned to apply the settings.

Refer to the *Honeywell Power Tools User Guide* available for download at sps.honeywell.com for more information on using EZConfig.

Scan Text Using Smart OCR

When scanning using Smart OCR, the recommended scanning distance is 6 to 30 centimeters.

1. Point the imager window at the text. For optimum performance, avoid reflections by scanning the barcode at a slight angle.
2. Press and hold any scan button.
3. Center the aiming beam over the text.
4. Release the scan button when the computer beeps, and the Good Read LED briefly turns on.
5. If Single Result is Disabled and Result String Mode is “Line”, select the results to use from the pop-up. If you do not select any results, the scan operation will dismiss after 20 seconds.

The scanned text is entered into the application in use.

USE THE CAMERA

Use this chapter to learn how to take pictures and record videos with the color camera.

About the Color Camera

The CK67 comes equipped with two cameras: an 8-megapixel camera located on the front and a 13-megapixel color camera on the rear. The CK67 offers 4K video with image stabilization, and advanced software features for enhanced exposure control for taking pictures and videos.

Use the Photos app  to view photos and videos stored on the CK67.



By default the photos and videos captured with the Camera app are saved on the computer under Internal shared storage\DCIM\Camera.

How to Zoom

The camera zoom is controlled using a pinching motion on the touch screen. Place two fingers on the screen at the same time, and then:

- spread them apart to zoom in (enlarge and object).
- pinch them together to zoom out.







Take a Photo

1. Tap the **Camera** icon  in the favorites tray on the Home screen.
2. Tap **Photo** (to use the default settings) or **ProMode** (to manually control settings for ISO, exposure, white balance, and focus).
3. Select  to switch between the front and rear camera. The front camera does not include a Flash feature

4. Using the screen as a viewfinder, move the computer until you see the image you want to capture. The camera lens is located on the back of the computer.
5. The camera automatically adjusts the focus but you can tap the screen to modify the focal point. By default, the camera senses the lighting in the environment and turns the flash on, if needed.
6. Tap  to take a photo.
 - To view the picture, tap the preview near the bottom of the screen.
 - To return to the Camera app, tap the **Back** navigation button.

Record a Video

This section explains how to record video with the camera in the computer.

1. Tap the camera icon  in the favorites tray.
2. Tap **Video** (to use the default frame rate) or **HFR** (to use a higher frame rate).
3. Tap  to start recording video.
 - To zoom in or out, pinch or spread your fingers apart.
 - To toggle sound recording on or off, tap the microphone icon at the top of the screen.
 - To pause recording, select . To resume recording, tap .
 - To capture a still picture during recording, tap the **Camera** icon .
 - To add light while recording, tap the flash icon. Flash is only available with the rear camera on the back of the computer.
4. When you are done recording, tap .

Change Camera Settings

You can change the camera settings for best results when taking pictures. The camera settings are adjustable from within the Camera app.

1. Open the **Camera** app .
2. At the top of the screen, select any of the following to adjust the settings.

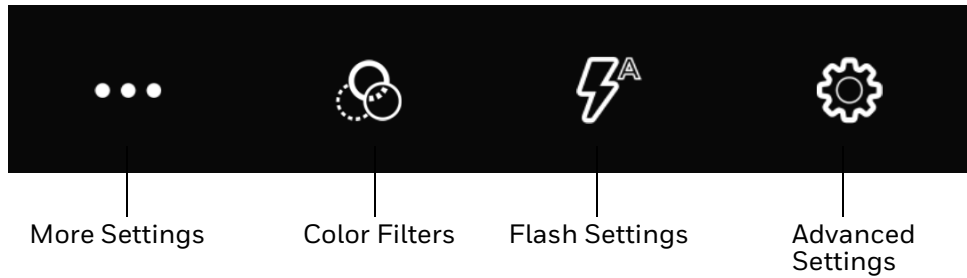

- **More Settings**
Select to access Automatic and HDR mode:
 - Automatic**
Select Automatic to have the camera automatically adjust the settings and focus for you.
 - HDR**
When High Dynamic Range (HDR) is enabled, the computer automatically captures multiple photos and combines them into one photo, creating the best quality image possible.
- **Color Filters**
Stylize your pictures by applying a filter. Options include: None, Mono, Sepia, Negative, Solarize, Posterize, and Aqua.
- **Flash Setting**
Select to adjust the camera flash setting (e.g., automatic, no flash, or always flash).
- **Advanced settings**
Select the gear  to access settings that allow you to modify the camera setting defaults and to configure how the camera app functions (i.e., General, Still camera, Video camera, System).

Use the Camera as a Flashlight

To use the camera as a flashlight.

1. Open Quick Settings (see page [39](#)).
2. Tap the **Flashlight** icon to turn the flashlight on.
 - Select the icon again to turn the flashlight off.

CONFIGURE THE COMPUTER

Use this chapter to learn about the available methods for configuring your mobile computer. You can also use this chapter to learn how to configure network communications and wireless security.

How to Configure the Computer

You can configure many parameters on the computer such as the barcode symbologies the integrated scanner decodes, or the network settings. The values you set for these parameters determine how the computer operates.

You configure the computer using the Settings app. Or you can use Wi-Fi Staging to set up multiple devices with the same base configuration (see page 94).

Start the Settings App

The Settings app is available from the all apps menu and the notification panel.

- Swipe up from the bottom of the Home screen to access all apps, and then tap **Settings** .

OR

- Swipe down from the top of the Home screen, and then select  in the status bar.

About the Structure of the Settings App

Use this section to learn about the structure of the Settings app so you can find parameters quickly. A search field appears at the top of the screen when you open the Settings app to help you locate settings quickly.

Note: *The Settings app varies by computer model and OS version. Your computer may not include all the features outlined in this section.*

Network & internet

In the Settings app, select **Network & internet** to access the following settings.

Setting	Description
Internet	<ul style="list-style-type: none">• Turn Wi-Fi radio on or off.• Lists available Wi-Fi networks in range and the connection status when the radio is turned on.• Add a network Wi-Fi connection and view saved networks.• Tap Network Preferences to turn on Wi-Fi automatically, notify for public networks, install certificates, use Wi-Fi Direct, and access Honeywell Wifi settings (see page 85).
Airplane mode	Turn Airplane mode on or off. Note: When Airplane mode is turned on, phone and Wi-Fi services are turned off. To use Wi-Fi while in Airplane mode, select Internet then choose a Wi-Fi network.
Ethernet	<ul style="list-style-type: none">• Turn Ethernet connection on or off.• Configure Ethernet connections and set up proxy settings when the Ethernet setting is turned on.
Data Saver	<ul style="list-style-type: none">• Turn the Data saver feature on or off.• Specify which apps can use unrestricted data.
VPN	Set the password parameters for a virtual private network (VPN) connection.
Private DNS	Select Private DNS Mode.

Connected devices

In the Settings app, select **Connected devices** to access the following settings.

Setting	Description
USB	<ul style="list-style-type: none">• Specify whether USB communication is controlled by your device or the connected device.• Select the type of communication:<ul style="list-style-type: none">• File Transfer• MIDI• PTP• No data transfer• Set up file transfer options when File Transfer or PTP is enabled. <p>Note: This setting only appears when the unit is connected via USB.</p>
Pair new device	<ul style="list-style-type: none">• Connect a Bluetooth Device.• Lists Bluetooth-enabled devices in range.• View and rename the computer.• View the computer Bluetooth address.
Saved devices	View previously connected devices.

Setting	Description
Connection preferences	
Bluetooth	<ul style="list-style-type: none"> • Turn the Bluetooth radio on or off. • View and rename the computer. • Connect to a Bluetooth Device. • Lists Bluetooth enabled devices in range when the radio is turned on.
NFC	Turn Near Field Communication (NFC) on or off. When the NFC radio is enabled, data exchanges are allowed when the computer touches another NFC enabled device.
Cast	Set up a Cast connection. Cast (project) audio and screen content to a secondary device such as a television.
Printing	Set up a printer connection with the CK67. Connection options include cloud print services, Wi-Fi printing via a router, or printing via NFC.
Quick Share	Share files with nearby devices.

Apps

In the Settings app, select **Apps** to access the following settings.

Setting	Description
Recently opened apps	View a list of recently opened apps or select "See all..." to view a list of installed apps on the computer and system services running.
General	
Default apps	View and manage default app use.
Screen time	<ul style="list-style-type: none"> • Show screen time, notifications received, times opened. • Set app timer.
Unused apps	View and manage apps that are unused for over three months.
App battery usage	Set battery usage options for apps.
Special app access	Manage apps with special unrestricted access.

Notifications

In the Settings app, select **Notifications** to access the following settings.

Setting	Description
Manage	
App notifications	Manage notifications from apps.
Notification history	Turn notification history on or off. View recent and snoozed notifications.
Conversation	
Conversations	View conversations marked as a priority.
Bubbles	Allow conversations to appear as floating icons on top of other apps.

Setting	Description
Privacy	
Device & app notifications	Control which apps and devices can read notifications.
Notifications on lock screen	Manage how notifications appear on the lock screen.
General	
Do Not Disturb	Turn on to prevent notifications from appearing. Manage which notifications can appear when Do Not Disturb is on.
Flash notifications	Flash the camera light or the screen when you receive notifications or when alarms sound.
Hide silent notifications in status bar	Turn on to prevent silent notifications from appearing in the status bar. Silent notifications are notifications that do not use a visual or audible alert.
Allow notification snoozing	Turn on to enable the ability to snooze a notification by tapping the alarm clock icon at the bottom of a notification.
Notification dot on app icon	Turn on to display a notification dot on an app icon when the app generates a notification.
Blink light	Turn on to enable the notification LED to blink for notifications.
Enhanced notifications	Turn on to organize notifications and enable notifications to provide suggested actions and replies.

Battery

In the Settings app, select **Battery** to view battery status, use statistics and adjust features that conserve battery charge.

Note: Some settings in previous OS versions can be found in Display.

Setting	Description
Battery	View current battery charge or charging status.
Battery usage	View battery usage from last full charge.
Battery Saver	Turn the Battery saver feature on or off manually. Set a schedule based on the battery charge percentage (%) remaining that automatically activates the Battery saver feature. Use the slider to set the battery percentage level. Slider adjusts from 5% to 7% and is only available once schedule is selected. When charging, set the battery saver feature to turn off when the battery reaches 90%. Default setting.
Battery percentage	Set to show or do not show battery percentage in status bar.

Storage

In the Settings app, select **Storage** to view statistics on available and used storage space on the device and on any portable storage cards installed.

Sound & vibration

In the Settings app, select **Sound & vibration** to modify the audio and sound settings. To learn more, see [Audio Settings](#) on page 29.

Display

In the Settings app, select **Display** to access the following settings.

Setting	Description
Brightness	
Brightness level	Set the Brightness level manually if the Adaptive brightness feature is turned off.
Adaptive brightness	Set how the screen in sleep mode responds when new notifications are received (e.g., wake or do not wake).
Lock Display	
Lock screen	Select what to show on the lock screen and when to display new notifications.
Screen timeout	<ul style="list-style-type: none">Set the inactivity time limit before the unit automatically turns of the screen to save battery power (seconds or minutes).Turn Screen Attention on or off. When Screen attention is turned on, the screen will not turn off if a user is looking at it.
Keypad backlight	
Backlight	Set the keypad backlight on or off.
Backlight timeout	Set the amount of time for the backlight to time out.
Appearance	
Dark theme	Enable dark mode to switch app backgrounds to a black color.
Display size and text	<ul style="list-style-type: none">Adjust Font size.Adjust Display size.Turn Bold text on or off.Turn High contrast text on or off.Reset settings.
Color	
Night Light	Activate the Night Light feature to adjust the screen tint to a light amber for easier viewing and reading in dim light or for the hours you use the device before going to sleep. Set the feature to stay on or define a schedule to turn the feature on or off. You can manually adjust the intensity of the amber hue once the feature is activated.
Colors	Adjust the screen color settings (e.g., Natural, Boosted, Adaptive).
Display white balance	Turn on to automatically adjust the white balance of the display to a warmer or cooler color temperature based on the ambient light.
Other display controls	
Auto-rotate screen	Set the screen to switch from portrait to landscape when the unit is rotated. When off, the screen does not automatically rotate.
Screen saver	Set the default screen saver as well as when to display it. Tap Settings to select screen saver style or to turn Night mode on.
QColor	Demo of Qualcomm display technology.

Wallpaper & style

In the Settings app, select **Wallpaper & style** to manage background images, colors and themes on the Home and Lock screens.

Accessibility

In the Settings app, select **Accessibility** to access screen readers, display settings, interaction controls, audio, and on-screen text features to improve accessibility levels.

Setting	Description
Screen reader	
TalkBack	When turned on, the feature provides spoken feedback so you can use the computer without always looking at the screen. TalkBack describes your actions and tells you about alerts and notifications.
Display	
Select to Speak	When turned on, you can tap specific items on the screen to hear them read aloud.
Display size and text	Configure display features that may aid visual accessibility levels. <ul style="list-style-type: none"> Adjust Font size. Adjust Display size. Turn Bold text on or off. Turn High contrast text on or off. Reset settings.
Color and motion	Configure color and motion features that may aid visual accessibility levels. <ul style="list-style-type: none"> Enable and manage Color correction options. Enable and manage Color inversion options. Turn Dark theme on or off. Turn Remove animations on or off Turn Large mouse pointer on or off.
Extra dim	Turn on to dim the screen beyond the minimum brightness level.
Magnification	Manage options to quickly zoom the screen to make content larger.
Interaction controls	
Accessibility Menu	Turn large on-screen menus on or off .
Switch Access	Turn the ability to control the computer with switches (such as an external device) on or off.
Timing controls	Manage timing options for actions. <ul style="list-style-type: none"> Adjust the Touch & hold delay. Time to take action (Accessibility timeout). Set the Autoclick delay (dwell timing) to automatically click after the pointer stops moving.
System controls	Set interaction controls that may aid physical accessibility levels. <ul style="list-style-type: none"> Set System navigation (Gesture navigation or 3-button navigation). Turn Auto-rotate screen on or off.

Setting	Description
Vibration & haptics	Enable and manage vibration and haptics features. <ul style="list-style-type: none"> • Turn Ring vibration on or off. • Turn Notification and Alarm vibration on or off. • Turn Touch feedback on or off. • Turn Media vibration on or off.
Captions	
Live Caption	Turn the Use Live Caption feature on or off and manage options for live captioning.
Caption preferences	Turn the Show captions feature on or off and manage options for captions.
Audio	
Audio Description	Turn on to hear a description of the action during supported movies and shows.
Flash notifications	Flash the camera light or the screen when you receive notifications or when alarms sound.
Hearing devices	Pair a hearing aid with the computer.
Audio adjustment	Manage audio options. <ul style="list-style-type: none"> • Turn Mono audio on or off. • Set Audio balance if using headphones or hearing aids.
General	
Accessibility shortcuts	Manage the accessibility button, which provides a shortcut for accessibility options from any screen.
Text-to-speech output	Select and configure the preferred TTS, language, speech rate, and pitch of synthesized voice.

Security & Privacy

In the Settings app, select **Security & Privacy** to view the latest Security scan results, security updates, and phone encryption status. Access additional settings related to device security.

Setting	Description
Settings	
App security	Access Google Play Protect to manually initiate a scan of the apps on the device to check for problems.
Device unlock	Activate and configure a screen lock (None, Swipe, Pattern, PIN, or Password).
Account security	Add a Google account to enable the Google Security Checkup feature.
Device finders	Use the Google Find My Device app to locate a lost device. A Google account is required.
System & updates	Check for security updates, system updates, and back up the device data. A Google account is required.

Setting	Description
Privacy	Manage security and privacy settings. <ul style="list-style-type: none"> • Permission manager • Privacy dashboard • Ads • Health Connect • Data sharing updates for location • Camera access • Microphone access • Show clipboard access • Show passwords • Location access • Activity controls
Other settings	
More Security & Privacy	Manage additional security and privacy settings. <ul style="list-style-type: none"> • Notifications on lock screen • Show media on lock screen • App content • Android System Intelligence • Autofill service from Google • Usage & diagnostics • Extend unlock • Device admin apps • Encryption & credentials • Trust agents • App pinning

Location

In the Settings app, select **Location** to define which apps have access to the device's location.

Setting	Description
Use Location	Turn location services (Google and GPS satellite data) on or off. Set location mode accuracy and view location request history.
App location permissions	View and manage app-level location service permissions.
Location services	
Earthquake alerts	Provides an alert when an earthquake is detected nearby. For supported regions only.
Emergency Location Service	Allows the device to automatically send its location to emergency locations.
Google Location Accuracy	Improves location accuracy by using Wi-Fi, mobile networks, and sensors to help estimate the device location.

Setting	Description
Google Location History	Allows the device to report Location History to Google. A Google account must be associated with the device to use this feature.
Google Location Sharing	Allows the device to share its location with anyone in the contacts list.
Wi-Fi scanning	Turn Wi-Fi scanning on or off. When enabled, system apps and services are allowed to detect Wi-Fi networks at any time to improve location services.
Bluetooth scanning	Turn Bluetooth scanning on or off. When enabled, system apps and services are allowed to detect Bluetooth devices at any time to improve location services.

Safety & emergency

In the Settings app, select **Safety & emergency** to manage options for sending and receiving information in an emergency.

Setting	Description
Emergency SOS	When turned on, you can press the Power button five times to call for help or sound an alarm.
Emergency Location Service	Allows the device to automatically send its location to emergency locations.
Earthquake alerts	Provides an alert when an earthquake is detected nearby. For supported regions only.

Honeywell Settings

In the Settings app, select **Honeywell Settings** to access the following settings.

Setting	Description
Battery LED	Configures the battery LED behavior. To learn more see, Change the Battery Status LED Behavior on page 12.
Battery Optimizer	View battery status and app usage information. Create and enable or disable a battery optimization profile that implements a group of settings to conserve power. Options include: <ul style="list-style-type: none"> • None When selected, no battery optimization profile is active. • Energy Saver This pre-defined profile implements UI settings that optimize battery conservation. • Custom Profile Tap to create a custom battery profile that balances your application needs with energy saving settings. You can turn location services on or off, configure sound and vibration options, modify brightness and timeout display options, turn UI transition animations on or off, and turn background services on or off.
Digital Scan Button	Enable and configure the optional digital scan button. To learn more, see About the Optional Digital Scan Button on page 56.

Setting	Description
Honeywell Power Setting	Turn Unattended Mode on or off. When Unattended Mode is on, healthcare apps will continue to notify clinicians of critical communication, even though the unit appears to be in sleep mode.
HXLogger	<p>The HXLogger is an advanced diagnostic log service that provides a basic log service, plug-ins for modified log services, and a log manager.</p> <ul style="list-style-type: none"> • Tap HXLogger to turn the basic log service on or off. When enabled, the service records app and system diagnostic troubleshooting information into four basic log files: main log file, radio log, event log, and kernel log. • Tap Plugin to view and enable additional log services and custom plug-ins. • Tap Manager, to change the default log path, delete logs or upload logs for technical support troubleshooting.
Key WakeUp	Set the buttons you want to use to wake the computer from sleep mode. Options include: Left Scan, Middle Scan, Right Scan. By default, the Left, Middle and Right Scan buttons are enabled for wake up.
Keyremap	Change (remap) a button or key function. To learn more, see Remap a Button or Key on page 38.
Provisioning Mode	Enable or disable unrestricted installation of applications, certificates, configuration files, and licenses. Provisioning mode is turned Off by default. To learn more About Provisioning Mode , see page 93.
Scanning	Configure the computer imager. To learn more, see Change the Scanner Settings on page 48.
Smart Sensor	Configures the integrated motion detection sensors for advanced power management. Options include: Keep awake on motion, Wake on motion, Face down suspend, Screen off in pocket.
Staging Hub Agent	Use the agent and settings to connect the computer to the Honeywell Staging Hub Foundation software platform; a centralized software platform IT integrators and administrators can use as a solution for managing, monitoring and deploying Honeywell devices in a connected workspace environment.
Sticky Option	Choose whether modifier keys are “sticky” (remain active). The default is off. To learn more about modifier keys, see page 21.
RFID	Manage default settings profiles for Honeywell RFID readers. To learn more, see Configure RFID Settings on page 101.
Touch Screen Profile	Optimize screen interactions by selecting a touch screen profile designed specifically for your use case. To learn more, see page 17.
UI Configs	Optimize space on the status bar by hiding HD icons.
Voice Wedge	Voice-to-text conversion tool that can be triggered by a specified start word or key press event. Voice Wedge can be configured to take effect globally or only for an associated application.
Web Applications	Enable access for Honeywell Mobility SDK for Web apps and port selection.
Wi-Fi Staging	Use the Honeywell Wi-Fi Staging app to quickly set up new devices by configuring one device and using it to stage others. Wi-Fi Staging can also be used to enroll devices in a Mobile Device Management (MDM) system by connecting units to a specified network and downloading and installing the specified MDM client app. To learn more, see page 94.

Passwords & accounts

In the Settings app, select **Passwords & accounts** to access the following settings.

Setting	Description
Passwords	Manage saved passwords.
Autofill service	Manage password management services.
Add account	Select to add and manage a Corporate or Email account on the computer.
Automatically sync app data	Turn auto-sync on or off for accounts. Turning the feature on allows apps to refresh data automatically.

Digital Wellbeing & parental controls

In the Settings app, select **Digital Wellbeing & parental controls** to access Digital Wellbeing tools and parental controls. For more information, see <https://wellbeing.google/>.

Google

In the Settings app, select **Google** to set up and manage your Google accounts and services.

System

In the Settings app, select **System** to access the following settings.

Setting	Description
Languages	<ul style="list-style-type: none">Set the preferred language for the computer and specific apps, as well as regional preferences.Set up voice input, on-device recognition, and text-to-speech output.
Keyboard	<ul style="list-style-type: none">Set and manage On-screen and Physical keyboard input methods.Configure the spell checker and personal dictionary.Adjust the pointer speed.
Gestures	<ul style="list-style-type: none">Turn Quickly open camera on or off.Set the system navigation options for buttons on the screen and swiping.Set the press and hold power button option to open the power menu or the Assistant.Set the Prevent ringing option. Options: Vibrate, Mute.
Date & time	Configure all date and time settings, see page 41.
Scheduled power on and off	Set a schedule to power the computer on or off.
Backup	Turn the Google Drive backup feature on or off. When enabled, phone data (e.g., apps, apps data, call history, contacts, device settings, SMS, Wi-Fi passwords and permissions) is automatically backed up to the Google Drive.

Setting	Description
Multiple users	<ul style="list-style-type: none"> • Enable or disable allowing multiple users. • Modify the owner profile name and add profiles for other people who use the computer. • Activate a different user profile. • Add a guest user or delete guest activity. • Enable or disable allowing users to be added from the lock screen.
Developer options	<p>Enable developer-specific options such as USB debugging and SD card protection.</p> <p>This option only appears under System settings if you enable the feature. To learn more, see Unlock Developer Options on page 45.</p>
Reset options	<p>Select from the following reset options:</p> <ul style="list-style-type: none"> • Reset Mobile Network Settings Use to reset all mobile network settings. • Reset Bluetooth & Wi-Fi Use to reset all Bluetooth and Wi-Fi settings. • Reset app preferences. Use reset app preference back to defaults. This apps you disabled, notification changes, default app actions set, background data restrictions for apps, and permission restrictions. • Enterprise data reset. To learn more, see Enterprise Data Reset the Computer on page 110. • Erase all data (factory reset). To learn more, see Erase All Data (Factory Reset) on page 111.

About Phone

In the Settings app, select **About Phone** to access the following information.

Setting	Description
Basic info	
Device name	A nickname to identify the device. To change, tap Device name and enter a new name.
Legal & regulatory	
Legal information	Provides links to third-party licenses and other legal information.
Compliance information	Displays certification and compliance information.
Device details	
Model	Displays the model number, serial number, and hardware version of the device.
Android version	The version of Android on the device. Tap to view additional details.
Device identifiers	
Asset number	Asset tag assigned to the device.
IP address	IP address associated with the device.
Wi-Fi MAC address	View information about saved Wi-Fi networks.

Setting	Description
Device Wi-Fi MAC address	Wi-Fi MAC address associated with the device.
Bluetooth address	Bluetooth address associated with the device.
Up time	Time the device has been running since powering on or restarting.
Software component version	Select to view software component version list.
Build number	Kernel number installed.

About Network Communications

You can easily add the mobile computer to your wireless or wired data collection network. Connect the CK67 your computer using:

- 802.11 a/b/g/n/ac/d/h/i/r/k/v/w/mc/ax radio communications.
- Ethernet communications.
- Bluetooth communications.
- USB and serial communications.

Connect to a Wi-Fi Network

The computer contains an 802.11 a/b/g/n/ac/d/h/i/r/k/v/w/mc/ax radio to transfer data using wireless communications. Before you connect to a Wi-Fi network, you need to know about your network security protocol and its required credentials.

By default, the 802.11 radio is disabled.

1. Swipe up from the bottom of the Home screen to access all apps.
2. Tap **Settings**  > **Network & internet** > **Internet**.
3. Tap **Wi-Fi** to toggle the radio on or off.
4. On the list, tap a network name to initiate a connection.

To add a network if it does not appear on the list:

- a. Navigate to the end of the discovered network list, and then tap **Add network**.
 - b. Type the Wi-Fi network name (SSID).
 - c. Choose a security protocol and add any required information.
 - d. Tap **Save**.
5. Enter any required information if the network is secured (e.g., password, key or certificate name).
 6. Tap **Connect**.



Once you connect to a saved Wi-Fi network:

- Tap the network name on the list to view details (e.g., status, signal strength, speed, frequency, security type).
- To edit connection details, tap the network name on the list to view details and then tap the Edit icon .
- The computer automatically connects to the same network when the network is in range and the WLAN radio is turned on.
- To view a list of only your saved networks, navigate to the bottom of the discovered network list. Tap **Saved networks**.
- To remove a network from your saved list, tap the network name and select **Forget**. You can do this for networks you no longer use.

Configure Proxy Settings for a Wi-Fi Network

If you need to connect to network resources through a proxy server, you can configure settings for the proxy server for each Wi-Fi network you add. By default, the Wi-Fi networks you add are not configured to connect through a proxy server.

Note: *Proxy settings apply only to the Wi-Fi network you modify. You must change proxy settings for each network requiring a proxy server.*

1. Swipe up from the bottom of the Home screen to access all apps.
2. Tap **Settings**  > **Network & internet** > **Internet**. The list of available Wi-Fi networks appears.
3. Select the network to display the Network details.
4. Tap the Edit icon .
5. Tap **Advanced options**.
6. Under **Proxy**, select **Manual**.
7. Enter the proxy settings for the network.
8. Tap **Save**.

Disable Wi-Fi Notifications



By default, when Wi-Fi is enabled, you receive notifications in the Status bar when the computer discovers a wireless network. You can disable these notifications.

1. Swipe up from the bottom of the Home screen to access all apps.
2. Tap **Settings**  > **Network & internet** > **Internet**. Verify the WLAN radio is turned on.
3. Navigate to the bottom of the discovered network list.

4. Select **Network preferences**.
5. Tap **Notify for public networks** to toggle the setting on or off.

Fix Connectivity

If you have connectivity issues, you can try to resolve the issue by resetting the Internet connection. The Fix Connectivity Function restarts the Wi-Fi subsystem and radio modem. Saved Wi-Fi networks are not erased by this action.

1. Swipe up from the bottom of the home screen to access all apps.
2. Tap Settings  > **Network & internet** > **Internet**.
3. Tap .
The Wi-Fi subsystem restarts and the radio modem resets.

Honeywell Wi-Fi Settings

To access Wi-Fi preference settings for advanced configuration of the wireless 802.11 radio in the mobile computer:

1. Swipe up from the bottom of the Home screen to access all apps.
2. Tap Settings  > **Network & internet** > **Internet**.
3. Tap **Network preferences**. The Configure Wi-Fi menu appears.
4. Tap **Honeywell Wi-Fi Settings**.
5. Tap a setting to enable or disable the option to access additional parameters that configure the Wi-Fi radio.

Connect to an Ethernet Network

To connect the computer to an Ethernet network, you need a CK67 Ethernet Home Base or a CK67 Net Base.

1. Make sure the base is connected to your Ethernet network.
2. Place the computer in the base.
3. Swipe up from the bottom of the Home screen to access all apps.
4. Tap **Settings**  > **Network & internet** > **Ethernet**. The Ethernet setting is turned on by default.
5. Tap **Ethernet**.

The Ethernet connection screen shows the current Ethernet connection. By default, the computer assumes a DHCP connection, and that your network has assigned an IP address automatically. If DHCP is working, the Ethernet base should indicate that communication with the network is occurring.

6. (Optional) To assign a static IP address.
 - a. Tap **DHCP** and then select **Static** from the list.
 - b. Enter the required network information, and then tap **Apply**.
7. Tap **Save**.

How to Connect to Virtual Private Networks

The computer supports connecting to virtual private networks (VPNs). This section describes how to add and connect to VPNs. To configure VPN access, you must obtain details from your network administrator. You can view and change VPN settings in the Settings app.

Note: Before you can add or connect to a VPN network, you must enable a screen lock method.



Add a VPN

Before you can connect to a VPN, you must create a VPN profile.

1. Swipe up from the bottom of the Home screen to access all apps.
2. Tap **Settings**  > **Network & internet** > **VPN**.
3. Tap **+** to add a VPN new profile.
4. Enter the required information for the VPN connection. If needed, swipe up on the screen to access all the required information fields.
5. Tap **Save**. The VPN name appears in the VPN list.

Connect to a VPN



Once a VPN profile is created, you can connect to the VPN at any time.

1. Swipe up from the bottom of the Home screen to access all apps.
2. Tap **Settings**  > **Network & internet** > **VPN**.
3. Type the name of the VPN in the list.
4. Enter any necessary credentials when prompted.
5. Tap **Connect**. A  appears in the status bar and a notification is received.

To disconnect from the VPN, tap the notification.

Edit VPN Information

Editing an existing VPN profile can be done from the VPN screen.

1. Swipe up from the bottom of the Home screen to access all apps.
2. Tap **Settings**  > **Network & Internet** > **VPN**.
3. Tap and hold the name of the VPN in the list.
4. Tap  to the right of the VPN profile you want to edit.
5. Edit the VPN settings as necessary.
6. When you are done, tap **Save**.

About Wireless Security

The computer provides these security solutions for your wireless network:

- Wi-Fi Protected Access 3 (WPA3™)
- Wi-Fi Protected Access 2 (WPA2™)
- Wi-Fi Protected Access (WPA™)
- 802.1x

Honeywell recommends WPA3 security with PSK (Personal) or 802.1x (Enterprise) key management.

Before you set security, you need to enable the radio, set the date, and set the SSID on your computer. To use 802.1x security, you need to load a root certificate on your computer. To use transport layer security (TLS) with 802.1x security, you also need to load a user certificate.

Use the Settings app to access and configure all wireless security settings.

About Certificates

You can use digital certificates to identify the computer for network access or authentication to servers. To use a certificate to identify your device, you must install it in the trusted credential storage on the computer.



Android supports DER-encoded X.509 certificates saved in files with a .crt or .cer file extension. To install a valid certificate with a .der or other extension, you must change the extension to .crt or .cer to install it.

Android also supports X.509 certificates saved in PKCS#12 key store files with a .p12 or .pfx extension. To install a valid key store file with another extension, you must change the extension to .p12 or .pfx to install it. When you install a certificate from a PKCS#12 key store, Android also installs any accompanying private key or certificate authority (CA) certificates.

Load a Certificate

To use a certificate, you must install it in the trusted credential storage on the computer.

Note: Apps such as email and browsers that support certificates allow you to install certificates directly from within the app. For more information, see the help that comes with the app.

1. Copy the certificate or key store from your PC to the mobile computer.
2. Swipe up from the bottom of the Home screen to access all apps.
3. Tap **Settings**  > **Security & privacy** > **More security settings** > **Encryption & credentials**.
4. Tap **Install a certificate**.
5. Select either **CA certificate**, **VPN & app user certificate**, or **Wi-Fi certificate**.
6. Tap the Menu icon , and then navigate to the location where you saved the certificate or key store.
7. Tap the certificate or key store to install it. If prompted, enter the key store password. Tap **OK**.
8. Enter a name for the certificate and tap **OK**.

Disable or Remove Certificates

If a user or system certificate is compromised, or your organization chooses not to trust it, you can disable or remove the certificate.

1. Swipe up from the bottom of the Home screen to access all apps.
2. Tap **Settings**  > **Security & privacy** > **More security settings** > **Encryption & credentials**.
3. Select **Trusted credentials**.

The trusted credentials screen has two tabs:

- **System** shows Certificate Authorities (CA) certificates permanently installed on the computer. They can only be disabled.
 - **User** shows CA certificates you have installed yourself. You can remove these certificates.
4. Tap the name of the certificate to you want to disable or remove. The Security certificate screen appears.
 5. Scroll to the bottom of the screen and tap **Disable** (for System certificates) or **Remove** (for User certificates).

6. Tap **OK**.

Note: You can enable a disabled System certificate but if you remove a User certificate, you must install it again to enable it.

About Bluetooth Communications

Your mobile computer is equipped to communicate with other devices using Bluetooth technology. The Bluetooth radio must be turned on to discover, pair, and connect to other Bluetooth devices. System bar icons indicate Bluetooth radio status.

Connect a Bluetooth Device

To connect to a Bluetooth device, you must turn on the Bluetooth radio and then select the device from a list of discovered devices.



1. Swipe up from the bottom of the Home screen to access all apps.
2. Tap **Settings**  > **Connected devices**.
3. Tap **+ Pair new device**. A list of Bluetooth devices appears.
4. Select a device on the list to initiate a pairing request.
5. When the pairing request message appears:
 - Verify the pairing PIN is the same on both device, and then tap **PAIR**.

OR

- If the pairing request requires a PIN, enter the **PIN**, and then tap **PAIR**.

When the device is successfully paired with the computer, the device name appears under Paired devices.

6. (Optional) Once paired to a device, you can connect manually to the device. Tap the device under Paired devices. The word “Connected” appears under the paired device name.

The status icon changes from  to .

- To disconnect a paired device, tap the name of the paired device and then tap **FORGET**.



Rename the Computer

You can change the name of the computer to make it easier to identify when pairing with other Bluetooth enabled devices and view statistics about received files.

1. Swipe up from the bottom of the Home screen to access all apps.
2. Tap **Settings**  > **Connected devices** > **Connection preferences** > **Bluetooth**.
3. Tap **Device Name**. Type the new name and then tap **Rename**.

Rename, Share or Unpair a Paired Device

You can rename a paired device to make it easier to identify it on the list or unpair the device to remove it from the paired list.

1. Swipe up from the bottom of the Home screen to access all apps.
2. Tap **Settings**  > **Connected devices** > **Saved devices**.
3. Tap  next to the paired device.
4. Take one of the following actions:
 - To rename the device, tap the Edit icon  , type the new name, and then tap **RENAME**.
 - To allow **Internet access** or **Contacts and call history sharing**, tap the check box next to the setting.
 - To unpair the device, tap **FORGET**.

About the Scanner Edge App

Your mobile computer is equipped to communicate with scanners using Bluetooth technology through the Scanner Edge app. The Bluetooth radio must be turned on. System bar icons indicate Bluetooth radio status.



The Scanner Edge app can also be used to update the firmware on a connected scanner. Refer to your scanner's user guide for more information.

To turn on the Bluetooth radio:

1. Swipe up from the bottom of the Home screen to access all apps.
2. Tap **Settings**  > **Connected devices** > **Connection preferences** > **Bluetooth**.
3. Tap **Use Bluetooth** to toggle the Bluetooth radio on or off.

Connect a Bluetooth Scanner

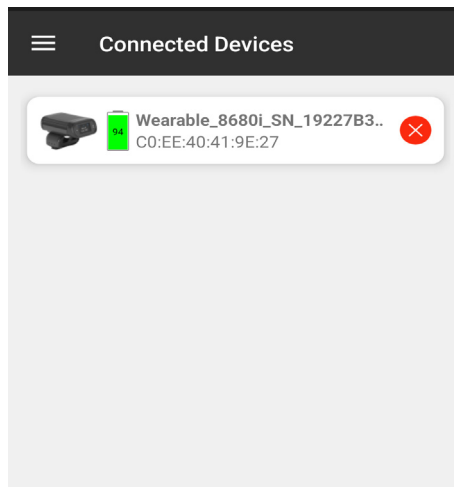

To connect to a Bluetooth scanner, the Bluetooth radio must be turned on and then scan a pairing barcode with the Bluetooth scanner.

1. Swipe up from the bottom of the Home screen to access all apps.
2. Tap **Scanner Edge** .
3. Tap the menu icon  and then tap **Pair BT Scanner**.
4. Scan the **Connect Barcode** displayed on screen.
5. When the scanner is successfully paired with the computer, the scanner name appears under Connected Device.



Unpair a Paired Scanner

You can unpair the scanner to remove it from the Connected Device list.

1. Swipe up from the bottom of the Home screen to access all apps.
 2. Tap **Scanner Edge** .
 3. To disconnect you can either:
 - Tap the menu icon , select Connected Devices, then tap the red X next to the scanner name.
- OR
- Tap the menu icon , then tap **Disconnect BT Scanner** and scan the **Disconnect Barcode** displayed on screen.

About Serial and USB Communications

You can use these optional CK67 accessories to transmit data to and receive data from another device through serial or USB communications:

- Vehicle dock
- Home Base
- Ethernet Home Base

For information about these accessories, contact your local sales representative.

USB Troubleshooting

- If you have a problem with your workstation computer recognizing the USB device, try downloading and installing the Honeywell-aidc-usb-driver. The driver is part of the Honeywell_Mobility SDK_Android software.zip file. To learn where to get the software, see [Developer Information](#) on page 93.
- Check to make sure you have enabled the USB for file transfer. To learn more, see [Configure USB Connection and Transfer Files](#) on page 32.

About Near Field Communication (NFC)

NFC technology provides the ability for short-range, wireless data transfer between the CK67 and NFC tags or other NFC enabled devices placed in close proximity to the back of the computer. All CK67 mobile computers support the following modes of operation:

- NFC tag reader/writer mode: The computer reads and/or writes digital information from or to an NFC tag.
- Peer-to-Peer (P2P) mode: The computer uses Android Beam and/or Bluetooth technology to transfer screen content (e.g., a picture, contact information, Web page URL, or file) between NFC enabled devices.
- NFC card emulation mode: The computer emulates an NFC card (smart card) that an external card reader can access. You can download and install apps for card emulation mode from the Google Play Store. Some examples include digital wallets (e-wallets) offered by your bank or credit card company and Google Pay.

The app you install determines the type of emulation mode used: Card Emulation with a Secure Element or Host-based Card Emulation. Secure element use is common for financial transactions that require a high level of security in order to provide a secure memory and execution environment for running custom smart card applets and storing your personal information (e.g., account information and credentials).

Note: *When using a Universal Integrated Circuit (UICC) card for NFC Secure Element NFC link encryption, install the card in SIM slot 1.*

Read an NFC Tag

To read an NFC tag, place the tag near the NFC antenna.

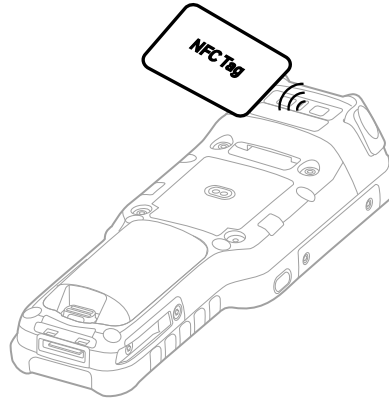

Note: NFC is on by default. To turn NFC off, go to **Settings**  > **Connected devices** > **Connection preferences** > **NFC**.

Developer Information

To download the Honeywell Mobility SDK for Android and EZConfig for Mobility:

1. Go to the *Technical Support Downloads Portal* at honeywell.com/PSSsoftware-downloads.
2. Create an account if you have not already created one. You must login to download the software.
3. Install the *Honeywell Download Manager* tool on your workstation (e.g., laptop or desktop computer) prior to trying to download any files.
4. Navigate to the software:
 - *Honeywell Mobility SDK for Android*
Click on **Software** > **Software and Tools** > **Developer Library** > **SDKs for Android**.
 - *EZConfig for Mobility*
Click on **Software** > **Software and Tools** > **EZConfig for Mobility**.
5. Select **Download** next to the software zip file.

About Provisioning Mode

Once you complete the out-of-box initial setup process, Provisioning mode is automatically turned Off to improve device security against unwanted modifications to the system.

When Provisioning mode is turned Off (disabled):

- Configuration barcodes do not scan and process.
- \honeywell\autoinstall folders are inaccessible.

Note: To learn more about network and security for Honeywell mobile computers with Android operating systems, go to sps.honeywell.com.

Enable or Disable Provisioning Mode

1. Swipe up from the bottom of the Home screen to access all apps.
2. Tap **Settings**  > **Honeywell Settings** > **Provisioning mode**.
3. Tap the button to toggle the provisioning **On** or **Off**.

About Wi-Fi Staging

You can use the Honeywell Wi-Fi Staging app to quickly set up new devices by configuring one device and using it to stage others. Wi-Fi Staging can also be used to enroll devices in a Mobile Device Management (MDM) system by connecting units to a specified network and downloading and installing the specified MDM client app.

Once you have set up a configuration in the Wi-Fi Staging app on the server device, Wi-Fi staging will use that device as a hotspot and wait for a client to connect to it. The configuration will be distributed to the client device once communication is established between the client and the server device.

Staging Devices

Wi-Fi Staging requires two steps:

1. Setting up a master device to act as a server (see next section).
2. Setting up the client device (see [Set Up Client Devices](#) on page 97).

Set Up a Device as a Server

Wi-Fi Staging provides two kinds of configurations for a master device acting as a server through a hotspot. Setup of the server device will differ based on the staging configuration you choose:

- **Basic Configs** include the most common system settings:
 - System language
 - Bluetooth and NFC
 - System volume

- Location
- Network
- File download
- Application installation or launch
- **Advanced Configs** allow you to stage your devices with .xml files

The hotspot on the server device will be named HONEYWELL_WIFI_STAGING.

Note: We recommend starting the server before setting any clients because the clients require more time and power to scan and search for the hotspot signal if the server is not created in advance.

Note: To control bandwidth usage, the server side of Wi-Fi Staging has a maximum limitation of 10 concurrent client connections. If more than 10 client devices attempt to connect to the server device at the same time, staging of some of those clients will be delayed until client connections become available as the staging process progresses.

Basic Configuration

Basic configuration includes the most common system settings.

1. Launch the Wi-Fi Staging app on the server device by tapping **Settings** > **Honeywell Settings** > **Wi-Fi Staging**.
2. Tap **Basic Configs** to start the configuration wizard.
3. **System language:** Tap + to add a language. At least one language must be selected. Tap **NEXT**.
4. **Connection preferences:** Enable Bluetooth and/or NFC. They are disabled by default. Tap **NEXT**.
5. **Sound preferences:** Adjust the default volume for each type of audio by dragging the slider, then tap **NEXT**.
6. **Location setting:** Enable the location switch. It is disabled by default. Tap **NEXT**.
7. **Network & internet:** You have the option to set up a network connection if, for example, you want to register devices to an MDM system or the devices need to use applications that require network access.

If you do not want to set up a network connection, tap **SKIP** and proceed to Step 9.

If you want to set up devices to connect to a Wi-Fi access point, enter the network information:

- a. Tap **Wi-Fi Security** and select either OPEN, WPA/WPA2 or WPA3.
- b. Enter the Wi-Fi SSID. This field cannot be empty. Then tap **OK**.
- c. Enter the Wi-Fi password. The password must be between 8 and 63 characters long. If you selected WPA/WPA2 or WPA3 a password is required.

- d. Tap **NEXT**.
8. **Files & Apks:** (This option will not display if you chose to skip the network settings in Step 7.) Enter the locations (URLs) of the files to be downloaded. The URL should end with the file that you want to download. Wi-Fi Staging will name the downloaded file with the file name in the URL.
 - For security, only Local Area Network URLs are supported. Wi-Fi Staging will ignore URLs from Wide Area Networks.
 - Supported network protocol is HTTP or HTTPS.
 - APK files are installed silently and automatically after download.
 - Optional: You can include a file's hash in the file name. Wi-Fi Staging supports hash algorithms SH1 and SHA256.
9. **Final Setting:** Select whether you want to reboot the device after staging is complete. You can also specify an action (intent) to launch Android activities. Then tap **Next**.
10. **Confirm & Staging:** Review the items you have configured. Tap **Confirmed, start staging now!** to begin. If you need to change a setting, tap the Back button to return to that screen.

Wi-Fi Staging will start a hotspot on the server device and wait for clients to connect.
11. Proceed to [Set Up Client Devices](#) on page 97.

Configurations will be distributed to any client that connects to the server device. Once the data transmission finishes successfully, the name and serial number of the configured client will display in the Wi-Fi Staging app on the server device, and the client device will skip the Android setup wizard.

Note: If you included a file's hash in Step 8, Wi-Fi Staging will validate that the hash of the file downloaded to a device matches what you specified. If the downloaded file's hash does not match, the file will be removed from the device.

Advanced Configuration

Advanced configuration allows you to stage your devices with one of more .xml files created by EZConfig or Enterprise Provisioner. For more information about generating .xml files, see the *Power Tools User Guide* or the *Enterprise Provisioner User Guide*.

Note: *Advanced Configuration supports .xml files only. Other file types will be ignored.*

Note: *Do not change the default names of .xml files. (For example, DeviceConfig.xml is acceptable, but DeviceConfig1.xml is not.)*

1. Choose one device to act as the server.
2. Launch the Wi-Fi Staging app on the server by tapping **Settings > Honeywell Settings > Wi-Fi Staging**.
3. Tap **Advanced Configs**.

4. Tap **File directory**.
5. Specify where on the server device the .xml files to be downloaded are located.
6. Tap **NEXT**.
7. Choose the files to be applied. Tap **NEXT**.
8. Review the files you have selected. If you need to change any files, tap the Back button. Otherwise, tap **Confirmed, start staging now!** to begin.
Wi-Fi Staging will start a hotspot on the server device and wait for clients to connect.
9. Proceed to [Set Up Client Devices](#) on page 97.

Set Up Client Devices

The Wi-Fi Staging client runs automatically on the initial boot of a new device. However, it must be started manually on existing devices.

New Devices

This section applies to new, out-of-the box devices only. For existing devices, see the next section.

1. Set up a server device (see page [94](#)).
2. Place the new devices to be configured within 1 meter (3 feet) of the server device and turn them on.

When a new device boots up and begins the setup wizard, it will attempt to retrieve configuration from the server device, and a staging progress screen will display.

Note: *Client devices should be kept on the Android Welcome or setup wizard screen during staging. If you finish the setup wizard manually the client side of Wi-Fi Staging will stop running.*

Configurations will be distributed to any client that connects to the server device. Once the data transmission finishes successfully, the name and serial number of the configured client will display in the Wi-Fi Staging app on the server device, and the client device will skip the Android setup wizard.

Existing Devices

To start the Wi-Fi Staging client on an existing device:

1. Set up a server device (see page [94](#)).
2. Turn on the client device and launch the Wi-Fi Staging app by tapping **Settings > Honeywell Settings > Wi-Fi Staging**.
3. Tap **To be Staged**.

4. A message will display notifying you that the Wi-Fi settings on the client device will be reset as part of the staging process. Tap **OK** to confirm you wish to proceed.

Staging will begin and a progress screen will display.

5. Place the device within 1 meter (3 feet) of the server device and it will begin searching the server hotspot for a configuration.

The client devices will attempt to retrieve configuration from the server device and a staging progress screen will display. Once the client device receives and applies the configuration successfully, the progress screen will be dismissed.

Note: *To stop the staging process on an existing device, tap the Back button on the client device.*

Log Files

Wi-Fi Staging saves a key process and exception log on the device in the following directory: /sdcard/honeywell/Android/data/com.honeywell.wifistaging/Log/

This directory can be accessed through USB if Provisioning Mode is enabled.

About Voice Wedge

Voice Wedge is a voice-to-text conversion tool that can be triggered by a specified start word or key press event. When Voice Wedge is activated, the mobile device can capture a user's speech and output it as text in a field in the selected app. Voice Wedge can be configured to apply globally across all apps or only for an associated application.

Note: *Because Voice Wedge is powered by Google speech recognition services, it is only available on Google Mobile Services (GMS) devices.*

Define Trigger Mode

You can define either a spoken word or a key press as the trigger to launch Voice Wedge.

1. Select **Settings**  > **Honeywell Settings** > **Voice Wedge**.
2. Tap the toggle button to turn Voice Wedge on.
3. Tap **Trigger mode**.
4. Tap **Start Word** to define a voice command as the trigger or **Key** to use a key press.
5. If you selected Start Word, tap **Trigger start word** then use the keypad to enter the word. The default trigger start word is "honey".

6. If you selected Key, tap **Trigger key** then select the key to be mapped. You can either press a button (for example, a scan button) or use a virtual key. Note that when a button or key is selected for Voice Wedge, its original use is no longer active.

Associate Applications

By default, Voice Wedge is associated with all applications. You have the option to associate Voice Wedge with a single app.

1. Select **Settings**  > **Honeywell Settings** > **Voice Wedge**.
2. Tap **Effective Coverage**.
3. Tap **Single app**.
4. Tap **App package name**.
5. Use the keyboard to enter the associated package name, for example, “com.android.chrome”, then click **OK**.
6. To limit Voice Wedge to a specific activity within an app, tap **App activity name** and use the keyboard to enter the activity name. For example, “com.google.android.apps.chrome.Main”.

Define Key Commands

Voice Wedge allows you to define some words so that they will be interpreted as commands rather than being displayed as text when you are speaking. When you say one of these words, Voice Wedge will send a key press.

Under **Key command**, select the check box for words that should be used as keys.

- Enter - When you say, “enter,” an Enter key will be sent.
- Tab - When you say, “table,” a Tab key will be sent.
- Space - When you say, “space,” a space key will be sent.

Select Data Type

By default, Voice Wedge enters both alphabetic and numeric characters. You can also choose to input only alpha or numeric characters.

1. Select **Settings**  > **Honeywell Settings** > **Voice Wedge**.
2. Tap **Data type**.
3. Tap the data type to input.

Examples:

Data Type	You say...	Voice Wedge inputs...
Any	abc123	abc123
Alpha	abc123	abc
Numeric	abc123	123

To Use Voice Wedge in an App

Follow these steps to use Voice Wedge in an application on your device. Note that if a specific application is defined in the App Package Name setting, Voice Wedge will only work if you are using that app.

1. Select an app on your device.
2. Tap a data entry field in the app.
3. Say the defined Trigger start word or press the Trigger key. A message indicates, "Waiting for voice input..."
4. Speak normally into the device. The text will populate the selected field.

About RFID Readers

Honeywell mobile computers can be paired with an RFID Reader to provide a high-performance mobile RFID solution. To read RFID tags, you can use applications that are coded to use the RFID reader or applications that receive data through the RFID wedge feature.

Use this chapter to understand how to configure settings that define how the mobile computer interacts with the Honeywell RFID Reader.

Change the RFID Settings

Changes you make to the Default profile apply to all applications with no profile assigned. To add an RFID Profile, see page [106](#).

1. Swipe up from the bottom of the Home screen to access all apps.
2. Tap **Settings**  > **Honeywell Settings** > **RFID**.
3. Tap an RFID reader model (IP30, IH25, IH40, IH45).

Note: Refer to the accessories catalog for your mobile device to determine compatible RFID Reader models.

4. Tap **Default profile**.
5. Select from the following:
 - **RFID Reader Settings**
 - **Filter Settings**
 - **Trigger Settings** (model dependent)
 - **Notification Settings**
 - **Data Processor Settings**
6. Modify the settings to meet your application needs.

To learn more about the RFID settings, see [Default RFID Settings](#) on page 102.

Restore Default Scan Settings

You can easily discard all changes made to the Default profile and restore the default values.

Note: When you choose the *Restore all defaults* option from a settings screen in a profile, all the settings in that profile return to their default values.

1. Open the **Default profile**.
2. Tap  in the upper right corner of any of the scan settings screens for the profile.
3. Tap **Restore all defaults**.

Default RFID Settings

Use the following sections to understand the settings available for RFID profiles. To learn how to create a new profile, see page [106](#).

RFID Reader Settings

You should not need to modify the RFID Reader Settings. The **Override recommended values** setting is disabled by default. The recommended RFID Reader Settings are designed to work in a wide range of environments.

RFID Reader Settings

Setting	Description	Default
Read Mode*	Select the RFID Read mode.	Event mode
User defined read mode*	Enter a custom read mode.	None
Tag Type*	Defines the types of RFID tags used in an application.	EPC Class 1 Gen 2
Override recommended values	Allow custom RFID reader settings to be created.	Disabled
Dense Reader Mode*	Allows the reader to hop between channels within a certain frequency spectrum to prevent other readers in the area from interfering with one another.	Disabled
Field Separator*	Sets the character to be used for separating fields in tag data. Choose from space (), comma (,), colon (:), semicolon (;), tab, caret (^), or tilde (~).	Space
ID Report*	Enables or disables tag ID reporting after a Read, Write, or Lock command is executed.	Disabled

*IP30 RFID Reader Settings only.

Setting	Description	Default
No Tag Report*	Enables or disables a NOTAG message, which is sent when no tags are found during execution of a Read, Write, or Lock command.	Disabled
Report Timeout (ms)*	Sets the timeout (in ms) for delays in tag reporting in continuous read mode. Range is 0 to 65534.	0
Initial Q*	Sets the initial Q parameter value used by the Query command. Valid range is 0 to 15.	4
Field Strength (dB)	Sets the RF power level (in dBm) for the antenna port.	Model dependent
Session	Sets the command session parameter to a corresponding EPCglobal Class 1 Gen 2 air protocol command.	Model dependent
Bluetooth Power Off (sec)*	Sets the time period (in seconds) for which the Bluetooth radio will search for a Bluetooth connection. Range is 30 to 3600.	300
Timeout or Tries*		
Timeout Mode*	Enables a timeout mode. Instead of specifying the number of antenna or ID tries, specify an antenna or ID timeout value. If the reader does not find any tags after an antenna or ID try, the reader waits this long before starting the next antenna or ID try. If you enable timeout mode, you need to set the ID Timeout and Antenna Timeout values.	Disabled
ID Timeout (ms)*	Sets the maximum time period (ms) during which attempts are made to find tags before a response is returned to a READ or WRITE command. Range is 0 to 65534.	100
Antenna Timeout (ms)*	Sets the maximum time period (ms) during which each antenna is used for a READ or WRITE command. Range is 0 to 65534.	50
ID Tries*	Sets the number of times an attempt is made to find tags before a response is returned to a READ or WRITE command. Range is 1 to 254.	1
Antenna Tries*	Sets the maximum time period (ms) during which each antenna is used for a READ or WRITE command. Range is 1 to 254.	3
Schedule Option*	Controls the behavior of ANTTIMEOUT, ANTRIES, IDTIMEOUT, and IDTRIES.	1
Read Tries*	Sets the number of times an attempt is made to read data from a tag before a response is returned to a READ command. Range is 0 to 254.	3
Write Tries*	Sets the number of times an attempt is made to write data to a tag before a response is returned to a WRITE command. Range is 1 to 254.	3
Initialization Tries*	Sets the initialization tries variable in the reader. Range is 1 to 254.	1
Lock Tries*	Sets the number of times an attempt is made to lock data on a tag before a response is returned to a Lock command. Range is 1 to 254.	3

*IP30 RFID Reader Settings only.

Setting	Description	Default
Select Tries*	Sets the number of times a group select is attempted. A group select is the command used to start the identify process. Range is 1 to 254.	1
Unselect Tries*	Sets the number of times a group unselect is attempted. Range is 1 to 254.	1

*IP30 RFID Reader Settings only.

Filter Settings

Use the Filter Settings to modify or reject data strings.

Filter Settings

Setting	Description	Default
Read filter script	Filter applied to raw tag results.	None
Debug level	Degree of detail in debug messages. The default level is 0, no information. Higher levels emit more information. Level 4 emits the most information.	0

Trigger Settings

Use the Trigger Settings to configure how the scan trigger functions. Trigger Settings is only available for some RFID reader models.

Trigger Settings

Setting	Description	Default
Enable reader trigger	Enable activating a scan by pressing the trigger on the RFID reader.	Enabled

Notification Settings

Use the Notification Settings to configure how your computer responds when you scan a barcode.

Notification Settings

Setting	Description	Default
Good Read Notification	Enables or disables a good read notification. The notification consists of a green blink of the Good Read LED, a short beep, and an optional short vibration.	Enabled
Bad Read Notification	Enables or disables notification of a failed scan. The notification consists of a red blink of the Good Read LED, an error beep, and an optional short vibration.	Disabled
Vibrate On Notification	Enables or disables whether the computer vibrates when there is a good or bad read.	Disabled

Data Processor Settings

Use the Data Processor Settings to specify how RFID tag data is processed by the computer.



Data Processor Settings

Setting	Description	Default
Wedge	Enable or Disable the wedge feature. Wedge must be enabled to pair the mobile device with an RFID reader using the RFID Pairing app.	Enabled
Wedge method	Specify wedge method: Standard or Keyboard. In Standard mode, the wedged data displays in a block format. In Keyboard mode, the wedged data is displayed character by character, similar to typing on a keyboard.	Standard
Charset	Select the character set to use when interpreting the tag binary data into a string.	ISO-8859-1
Prefix	Defines the string added to the front of the tag data.	None
Suffix	Defines the string added after the tag data.	None
Wedge as keys	List of character values to wedge as keys, represented as a comma-separated list of decimal values.	9,10,13
Launch browser	Enable or disable a browser being launched when the tag data starts with http:// or https://. The browser opens using the tag data as a URL.	Enabled
Tag to intent	Launches an app specified by the tag when data begins with //.	Enabled
Launch EZConfig	Enable or disable special handling of EZConfig barcodes. Applies to EZConfig barcodes that are encoded with the Aztec symbology and contain specific header data. Corresponds to BarcodeReader property: PROPERTY_DATA_PROCESSOR_LAUNCH_EZ_CONFIG	Enabled
Data intent		
Data intent	Data intent	Disabled
Action	Data intent action property	None
Category	Data intent category property	None
Package name	Data intent package name	None
Class name	Data intent class name	None
Extra key	Data intent extra key name	None
Data Editing Plugin		
Data Editing Plugin	Name of the plugin used to manipulate tag data.	None
Edit settings	The edit data settings property.	None

Add an RFID Profile

The mobile computer has a default profile for each RFID Reader model. You can also create custom profiles as needed for your use case. Profiles are created for the RFID model.

To create an RFID profile for a custom app on the computer:

1. Swipe up from the bottom of the Home screen to access all apps.
2. Tap **Settings**  > **Honeywell Settings** > **RFID** > <RFID Reader model>.
3. Tap  in the upper right corner of the app screen.
4. Take one of the following actions:
 - Tap the **profile name** field and then add a new name. Then click **OK**.

OR

- Tap the **select an application** option, and then choose an app from the list.

The new profile appears on the RFID profile list for the selected device type. You can now select and modify the scan settings for the new profile.

Delete an RFID Profile

1. Swipe up from the bottom of the Home screen to access all apps.
2. Tap **Settings**  > **Honeywell Settings** > **RFID** > <Device type>.
3. Tap and hold the profile you want to delete, select **Delete** and then click **OK**.

MANAGE AND MAINTAIN THE COMPUTER

Use this chapter to understand how to upgrade software, reset, and maintain the computer.

About Software Updates and Cyber Security

Cyber security best practices include keeping your device apps and OS up to date. To help, Honeywell offers maintenance patches, security updates and operating system upgrades through our Honeywell Edge services.

Availability and cost depend on the following:

- Date of purchase of the device or software app.
- Warranty status.
- Service agreement status (devices) or Maintenance plan status (apps).

To learn more about Honeywell Edge Services, go to sps.honeywell.com and select **Services > Productivity > Support Services**.



Honeywell recommends routinely checking the [Cyber Security Notifications](#) page for critical Cyber Security Notifications and to download the latest Network and Security Guides.

Software Downloads

Product support is available online through [Technical Support](#). Software updates can be accessed through the [Software Downloads](#) portal. You will need to create a login account for portal access. Additional information such as purchased date, service agreement number, maintenance plan number, or software license number may be required for downloads.

1. Go to honeywell.com/PSSsoftware-downloads.
2. Create a login account if you have not already created one.
3. Install the Honeywell Download Manager tool. See “Note” on the portal page. This tool is required for downloads.



4. Locate the app or upgrade you want to download in the Software directory.
5. If prompted, enter additional information, and click **Submit**.
6. Select **Download**. Follow the prompts to download the file.

About Transferring Files via USB Connection

If you plan on using a USB connection to transfer the upgrade files to the mobile computer, make sure you set the USB connection to allow file transfers. To learn more, see [Configure USB Connection and Transfer Files](#) on page 32.

Install Software with AutoInstall

Important: *The CK67 must have power for the entire length of the install process or it could become unstable. Do not attempt to remove the battery during the process.*

1. Swipe up from the bottom of the Home screen to access all apps.
2. Tap **Settings**  > **Honeywell Settings** > **Provisioning mode**.
3. Tap the toggle button to turn Provisioning mode on.
4. Save the upgrade file (*.zip or *.apk) in one of the following folders on the CK67 mobile computer:
 - **Internal shared storage\honeywell\autoinstall**
Software upgrades saved to this folder for installation do not persist when an Erase all data (factory reset) or Enterprise data reset is performed.
 - **IPSM card\honeywell\autoinstall**
Software upgrades saved to this folder do not persist when an Erase all data (factory reset) is performed. However, the upgrade does persist if an Enterprise data reset is performed.
5. Swipe up from the bottom of the Home screen to access all apps.
6. Tap **AutoInstall Settings**  and verify **Enable AutoInstall** is on .
7. Tap **Packages Update** from the AutoInstall Settings screen.



The computer automatically initiates a reboot and installs the software upgrade. The system update screen appears during the upgrade process. When the update is finished, the lock screen appears.
8. Once installation is complete, turn Provisioning mode Off.

Note: *Some updates do not require the computer to reboot before installation.*

Optional microSD Card Method

The CK67 comes equipped with a microSD card socket. You can install an upgrade from a microSD card you insert in the computer.

Important: *The CK67 must have power for the entire length of the install process or it could become unstable. Do not attempt to remove the battery during the process.*

1. On the CK67, swipe up from the bottom of the Home screen to access all apps.
2. Tap **Settings**  > **Honeywell Settings** > **Provisioning mode**.
3. Tap the toggle button to turn Provisioning mode on.
4. Swipe up from the bottom of the Home screen to access all apps.
5. Tap **AutoInstall Settings** . Verify **Enable AutoInstall** is on .
6. Press and hold the **Power** button, and then tap **Power off**.
7. On your workstation (e.g., laptop, desktop computer), format the microSD card and create a **\honeywell\autoinstall** folder on the root of the card.
8. Save the upgrade file (*.zip or *.apk) file in the **autoinstall** folder.
9. Install the microSD card in the CK67, and then turn on the computer.

The computer automatically runs the upgrade found in the autoinstall folder on the card. The system update screen appears during the upgrade process. When the upgrade is finished, the lock screen appears.

10. Once installation is complete, turn Provisioning mode Off.

About the Honeywell Upgrader

Use the Honeywell Upgrader app (HUpgrader) to automatically search for and install Over-the-Air (OTA) operating system updates from a remote server. The app can also be used to manually initiate a search for OS updates, update the OS using a file downloaded to the mobile device, and downgrade the operating system to a previous version. Refer to the HUpgrader User Guide available at sps.honeywell.com for more information.

Restart (Reboot) the Computer

You may need to reboot the computer to correct conditions where an application stops responding to the system.

1. Save your files and close any open applications.
2. Press and hold the **Power** button until the options screen appears.

3. Tap **Power > Restart**.

If the touch panel display is unresponsive:

- Press and hold the **Power** button for approximately 8 seconds until the computer reboots.

About Enterprise Data Reset

You can perform an Enterprise data reset if a Reboot did not improve the condition and all other troubleshooting methods have not resolved the issue. This method provides a clean configuration for troubleshooting by erasing all data from the **Internal shared storage** location on the computer. Data is not erased from the IPSM Card location.



Caution: An Enterprise data reset results in data loss, only perform this procedure if all other recovery methods have failed. All personal content is erased including, but not limited to emails, pictures, contacts, Google account information, system settings and app settings.

Note: *This method of recovery may not be available if your system administrator has set policies to prevent the reset use.*

Before You Begin

- If you recently reset your Google Account password, wait 24 hours before performing an Enterprise data reset.
- Make sure you have your screen lock password, PIN or pattern if you activated one. You will need this to reset the computer.
- If you have a Google Account, back up your data and settings to your Google Account so you can restore them if needed.
- Connect the computer to an external power source or make sure you have a full battery charge.
- Make sure you have an Internet connection.

Enterprise Data Reset the Computer

1. Swipe up from the bottom of the Home screen to access all apps.
2. Select **Settings**  > **System > Reset options**.
3. Tap **Enterprise data reset**.
4. Tap **Erase all data**.
5. If prompted, type your screen lock security pattern, PIN, or password.

6. Tap **Erase all data**. A message appears informing you an Enterprise data reset is being performed.

About Erase All Data (Factory Reset)

A full Factory Reset should only be performed if you have exhausted all other troubleshooting options including an Enterprise data reset. This method reverts the computer back to the factory state by erasing all data in **Internal shared storage** and the **IPSM Card** storage locations on the computer.



Caution: A full Factory Reset results in data loss. Perform this procedure only if all other recovery methods have failed and have no other option. All personal content is erased including, but not limited to emails, pictures, contacts, Google account information, system settings and app settings.

Note: *This method of recovery may not be available if your system administrator has set policies to prevent the reset use.*

Before You Begin

- If you added a Google Account to the computer, make sure you have your Google username and password associated with the computer. If you do not have the username and password, you will not be able to use the computer after the reset. This is a security measure that prevents unauthorized users from using the device if they try a Full factory reset.
- If you did not add a Google Account to the computer, the extra security level is not enabled and you will not need a Google username and password.
- If you recently reset your Google Account password, wait 24 hours before performing a Full factory reset.
- Connect the computer to an external power source or make sure you have a full battery charge.
- Make sure you have an Internet connection.

Erase All Data (Factory Reset)

1. Swipe up from the bottom of the Home screen to access all apps.
2. Select **Settings**  > **System** > **Reset options**.
3. Tap **Erase all data (factory reset)**.
4. Tap **Erase all data**.
5. If prompted, type your screen lock security pattern, PIN, or password.
6. Tap **Erase all data**. A message appears informing you a Full factory reset is being performed.

Repairs

Repairs and/or upgrades are not to be performed on this product. These services are to be performed only by an authorized service center (see [Customer Support](#) on page xi).

Maintenance

Your device provides reliable and efficient operation with a minimum of care. Although specific maintenance is not required, the following sections describe periodic checks to ensure dependable operation.

Clean the Computer

A cleaning guide is provided on the product page at sps.honeywell.com. Please refer to this guide for a list of approved cleaners for your device.

Note: *Reading performance may degrade if the scanner window is not clean. If the window is visibly dirty, or if the scanner is not operating well, clean the window.*



Caution: **Do not submerge the computer in water or cleaning solution. Do not use abrasive wipes or cloths on the windows or touch screen. Abrasive wipes may scratch the windows and touch screen. Never use solvents (e.g., acetone) on the housing or window. Solvents may damage the computer finish, the windows or touch screen.**

Caution: **Ensure all components are dry prior to mating the computer with charging accessories or other peripheral devices. Mating wet components may cause damage not covered by the warranty.**

Computer Agency Information

CK67 mobile computers meet or exceed the requirements of all applicable standards organizations for safe operation. The best way to ensure safe operation is to use the mobile computer according to the agency guidelines on the product regulatory sheet, quick start guide, battery insert, and in this user guide. Read all guidelines before using your computer.

Product documentation is available for download from sps.honeywell.com.

Public certificates are available for download from honeywell.com/PSScompliance.

Label Locations

Labels inside the battery compartment contain information about the computer, including compliance information, model number, serial number, and MAC address. Laser safety labeling is located on the back of the computer.

Product Identification Numbers
(e.g., Serial Number, MAC address or IMEI)

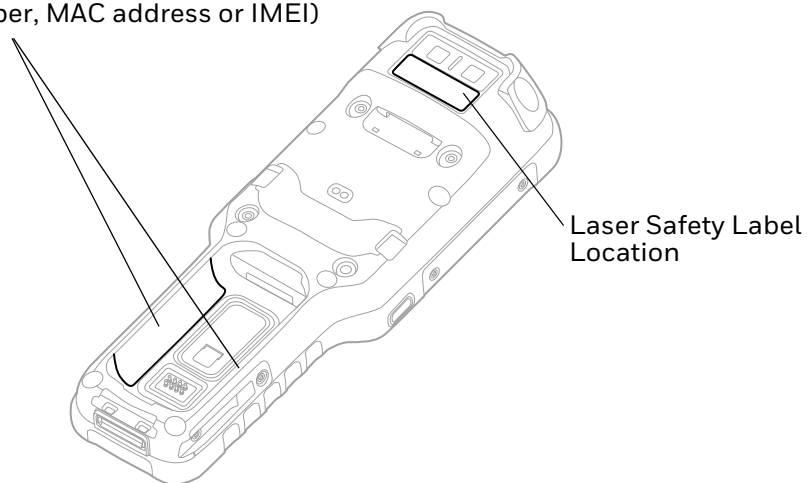

Laser Safety Label
Location

Physical and Environmental Specifications

1. Go to sps.honeywell.com.
2. Type CK67 in the Search box and then press **Enter**.
3. Click on the product link in the search results
4. Select one of the following:
 - **Specifications**
View Features, Software and Firmware, Memory & Data, Hardware, and Environmental specifications.
 - **Resources**
View and download available product documentation. For example, the Data Sheet, Accessory Guide, Quick Start Guide, User Guide, Regulatory Information, and Battery Information.

Barcode Symbologies Supported

The computer supports the following barcode symbologies:

1D Symbologies		2D Symbologies		Postal Codes	
	Default		Default		Default
Codabar	Enabled	Aztec Code	Enabled	China Post	Disabled
Code 39	Enabled	Codablock A	Disabled	Korean Post	Disabled
Code 11	Disabled	Codablock F	Disabled	2D Postal Settings	Disabled
Code 93	Disabled	Data Matrix	Enabled		
Code 128	Enabled	Digimarc	Disabled		
Composite	Disabled	DotCode	Disabled		
EAN-8	Enabled	Grid Matrix	Disabled		
EAN-13	Enabled	Han Xin	Disabled		
GS1-128	Enabled	Maxicode	Disabled		
GS1 DataBar	Disabled	MicroPDF417	Disabled		
IATA 2 of 5	Disabled	OCR	Disabled		
Standard 2 of 5	Disabled	PDF417	Enabled		
Interleaved 2 of 5	Enabled	QR Code	Enabled		
Matrix 2 of 5	Disabled	TLC 39	Disabled		
MSI	Disabled				
Telepen	Disabled				
Trioptic	Disabled				
UPC-A	Enabled				
UPC-E	Enabled				

Note: To learn about changing the symbology settings, see [Change the Scanner Settings](#) on page 48.

S0703-SR Standard Range Imager Reading Distances

The depth of field measurements used the following parameters:

- Distances are measured from the front of the Imager.
- +23 °C (+73 °F), 0 lux for guaranteed, 200 lux for typical.
- Photographic quality codes

Note: Time to Read and Depth of Field will be impacted if the barcode symbol is at the edge of the image.

Guaranteed Specs

Focus		Standard Range	
Symbology		Near Distance	Far Distance
5 mils Code 39	mm	79	270
	in.	3.11	10.63
10 mils Code 39	mm	40	425
	in.	1.57	16.73
20 mils Code 39	mm	44	674
	in.	1.73	26.53
13 mils UPC-A	mm	44	493
	in.	1.73	19.41
15 mils Code 128	mm	42	572
	in.	1.65	22.52
10 mils Data Matrix	mm	83	236
	in.	3.27	9.29
6.7 mils PDF417	mm	96	236
	in.	3.78	9.29
15 mils QR	mm	39	390
	in.	1.54	15.35
¹ Minimum distance depends on the length of the barcode. ² Typical code wide to narrow elemental ratio is 3:1. Minimum 100 mils code height of 3 inches.			

Typical Specs

Focus		Standard Range	
Symbology		Near Distance	Far Distance
5 mils Code 39	mm	70	301
	in.	2.75	11.85
10 mils Code 39	mm	40	517
	in.	1.57	20.35
20 mils Code 39	mm	44	800
	in.	1.73	31.50
13 mils UPC-A	mm	44	573
	in.	1.73	22.56
15 mils Code 128	mm	42	650
	in.	1.65	25.59
10 mils Data Matrix	mm	72	297
	in.	2.83	11.69
6.7 mils PDF417	mm	84	244
	in.	3.31	9.61
15 mils QR	mm	39	414
	in.	1.54	16.30

¹ Minimum distance depends on the length of the barcode.
² Typical code wide to narrow elemental ratio is 3:1. Minimum 100 mils code height of 3 inches.

S0703-SR Standard Range Imager Field of View/Resolution

Focus	Standard Range (SR)
Horizontal Field Angle (degrees)	44 ± 2°
Vertical Field Angle (degrees)	28 ± 2°

Note: DPI can be calculated based on the following formula:
 Horizontal DPI = 1280 pixels/width of horizontal field of view (inches)
 Vertical DPI = 800 pixels/width of vertical field of view (inches)

S0803-FR FlexRange Imager

The depth of field measurements used the following parameters:

- Distances are measured from the front of the Imager.
- +23 °C (+73 °F), 200 lux for guaranteed, 200 lux for typical.

- Photographic quality codes.

Note: *Time to Read and Depth of Field will be impacted if the barcode symbol is at the edge of the image.*

Guaranteed Specs

Focus		Standard Range	
Symbology		Near Distance	Far Distance
5 mils Code 39	mm	138	365
	in.	5.43	14.37
10 mils Data Matrix	mm	152	387
	in.	5.98	15.23
10 mils Code 39	mm	94	1198
	in.	3.70	47.17
13 mils UPC-A	mm	68	1437
	in.	2.68	56.57
15 mils Code 128	mm	66	1571
	in.	2.59	61.85
20 mils Code 39	mm	63	2161
	in.	2.48	85.07
100 mils Data Matrix ¹	mm	-	4505
	in.	-	177.36
55 mils Code 39 ¹	mm	-	6546
	in.	-	257.72
100 mils Code 39 ^{1,2}	mm	-	9843
	in.	-	387.51
¹ Minimum distance depends on the length of the barcode. ² Typical code wide to narrow elemental ratio is 3:1. Minimum 100 mils code height of 3 inches.			

Typical Specs

Focus		Standard Range	
Symbology		Near Distance	Far Distance
5 mils Code 39	mm	122	414
	in.	4.80	16.30
10 mils Data Matrix	mm	135	419
	in.	5.31	16.50
10 mils Code 39	mm	85	1368
	in.	3.35	53.86
13 mils UPC-A	mm	60	1600
	in.	2.36	62.99
15 mils Code 128	mm	58	1894
	in.	2.28	74.57
20 mils Code 39	mm	56	2645
	in.	2.20	104.13
100 mils Data Matrix ¹	mm	-	5641
	in.	-	222.09
55 mils Code 39 ¹	mm	-	7159
	in.	-	281.85
100 mils Code 39 ^{1,2}	mm	-	10815
	in.	-	425.78

¹ Minimum distance depends on the length of the barcode.
² Typical code wide to narrow elemental ratio is 3:1. Minimum 100 mils code height of 3 inches.

S0803-FR FlexRange Imager Field of View/Resolution

Near Field Optical System

- Horizontal FOV: 48°
- Vertical FOV: 31°

Note: DPI can be calculated based on the following formula:
 Horizontal DPI = 1920 pixels/width of horizontal field of view (inches)
 Vertical DPI = 800 pixels/width of vertical field of view (inches)

Far Field Optical System

- Horizontal FOV: 22°
- Vertical FOV: 12°

Note: DPI can be calculated based on the following formula:
 Horizontal DPI = 1280 pixels/width of horizontal field of view (inches)
 Vertical DPI = 800 pixels/width of vertical field of view (inches)

S0803-LR FlexRange XLR Imager Reading Distances

The depth of field measurements used the following parameters:

- Distances are measured from the front of the Imager
- +23 °C (+73 °F), 200 lux for guaranteed and typical
- Photographic quality codes

Note: Time to Read and Depth of Field will be impacted if the barcode symbol is at the edge of the image.

Guaranteed Specs

Focus		Standard Range	
Symbology		Near Distance	Far Distance
5 mils Code 39	mm	138	365
	in.	5.43	14.37
10 mils Data Matrix	mm	152	387
	in.	5.98	15.23
10 mils Code 128	mm	94	1491
	in.	3.70	58.70
13 mils UPC-A	mm	68	2000
	in.	2.68	78.74
20 mils Code 39	mm	63	5600
	in.	2.48	220.47
55 mils Code 39 ¹	mm	-	12500
	in.	-	492.13
100 mils Code 39 ^{1,2}	mm	-	20000
	in.	-	787.40
100 mils Data Matrix ¹	mm	-	6500
	in.	-	255.91

¹ Minimum distance depends on the length of the barcode.

² Typical code wide to narrow elemental ratio is 3:1. Minimum 100 mils code height of 3 inches.

Typical Specs

Focus		Standard Range	
Symbology		Near Distance	Far Distance
5 mils Code 39	mm	125	469
	in.	4.92	18.46
10 mils Data Matrix	mm	140	441
	in.	5.51	17.36
10 mils Code 128	mm	88	2021
	in.	3.46	79.57
13 mils UPC-A	mm	56	2090
	in.	2.20	82.28
20 mils Code 39	mm	60	6341
	in.	2.36	249.65
55 mils Code 39 ¹	mm	-	15425
	in.	-	607.28
100 mils Code 39 ^{1,2}	mm	-	26197
	in.	-	1031.38
100 mils Data Matrix ¹	mm	-	11718
	in.	-	461.34

¹ Minimum distance depends on the length of the barcode.
² Typical code wide to narrow elemental ratio is 3:1. Minimum 100 mils code height of 3 inches.

S0803-LR FlexRange XLR Imager Field of View/Resolution

Near Field Optical System

- Horizontal FOV: 48°
- Vertical FOV: 21°

Note: *DPI can be calculated based on the following formula:
 Horizontal DPI = 1920 pixels/width of horizontal field of view (inches)
 Vertical DPI = 800 pixels/width of vertical field of view (inches)*

Far Field Optical System

- Horizontal FOV: 13.7°
- Vertical FOV: 7.6°

DPI can be calculated based on the following formula:

Horizontal DPI = 1920 pixels/width of horizontal field of view (inches)

Vertical DPI = 1080 pixels/width of vertical field of view (inches)

Honeywell
855 S. Mint Street
Charlotte, NC 28202

sps.honeywell.com