

NAUTIZ X41

MANUAL



handheld

CONTENT

- 1. Introduction 3
 - 1.1 Appearance of Nautiz X41 3
 - 1.2 Installing the Battery 4
 - 1.3 Removing the Battery 5
 - 1.4 Installing a SIM card 6
 - 1.5 Installing a micro-SD card..... 7
- 2. Barcode scanner 8
- 3. User define functions..... 9
- 4. Keypad 11

1. INTRODUCTION

1.1 Appearance of Nautiz X41

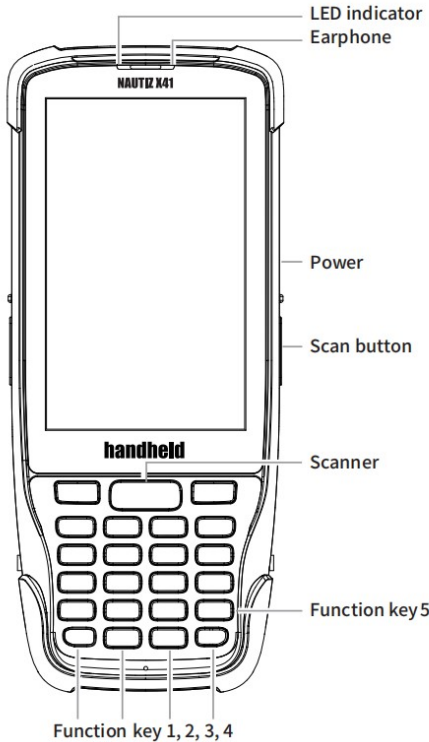

FIGURE 1-1 FRONT VIEW OF NAUTIZ X41

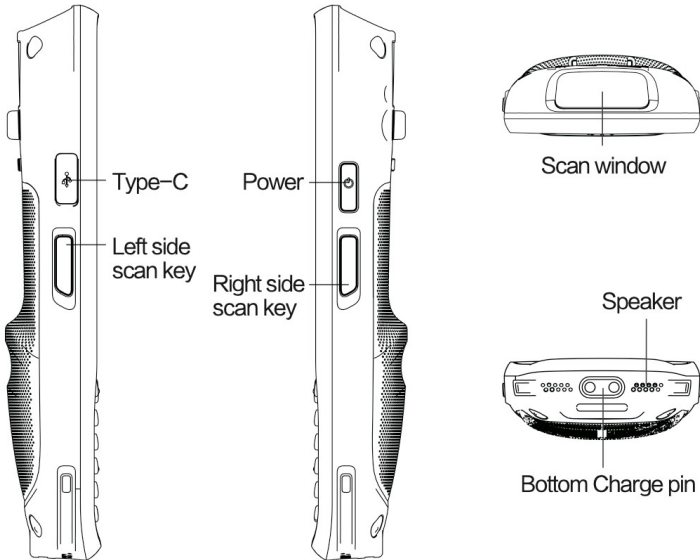
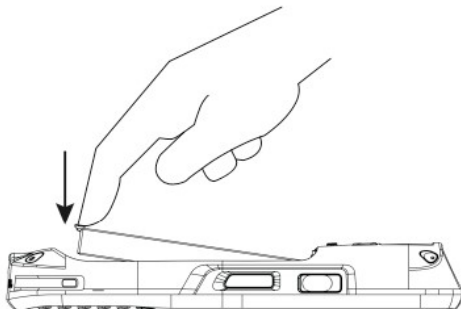

FIGURE 1-2 SIDE VIEW OF NAUTIZ X41

1.2 Installing the Battery

1. Put the battery into the battery compartment from upper side and press downwards.



2. Insert the battery cover to the bottom then press onwards.

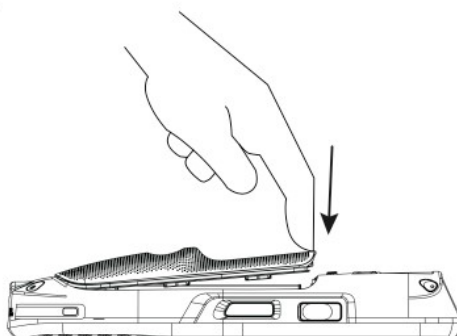

3. Slide left to lock

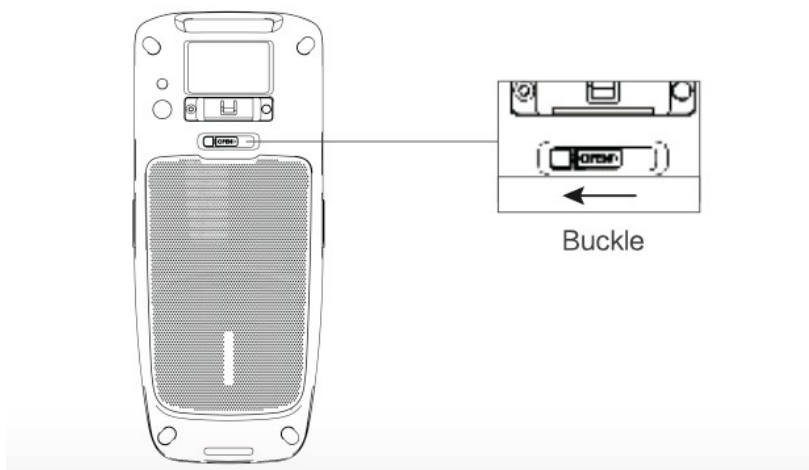

1.3 Removing the Battery

1. Slide right to unlock

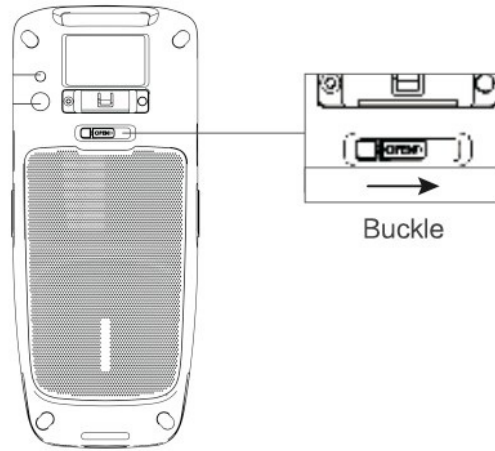

2. Pull up the battery cover from upper side

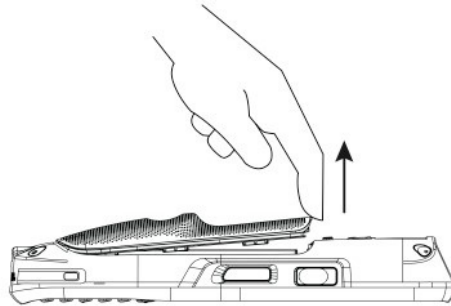

3. Pull up the battery

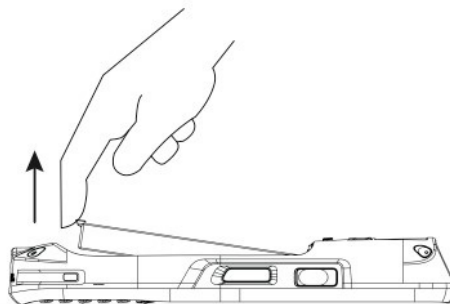

1.4 Installing a SIM card

1. Push the cover to OPEN direction and flip cover.

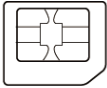

Micro SIM Card

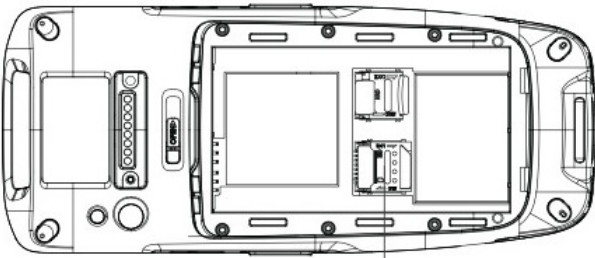

SIM Card

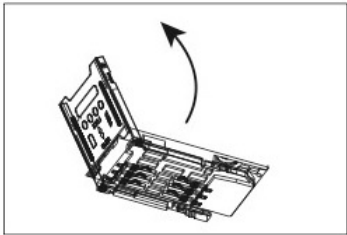
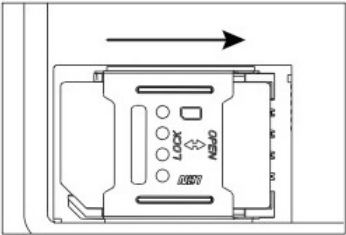

2. Insert SIM card, cover up then push it to LOCK direction.

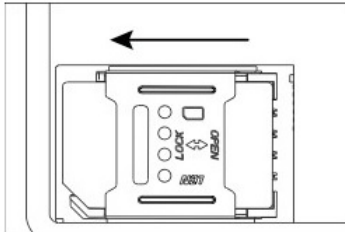
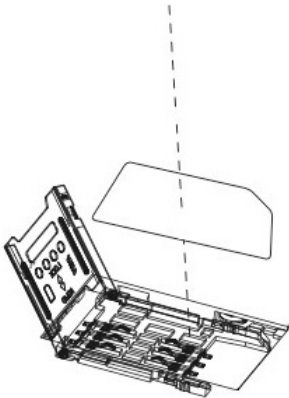

1.5 Installing a micro-SD card

1. Push the cover to OPEN direction and flip over storage card.

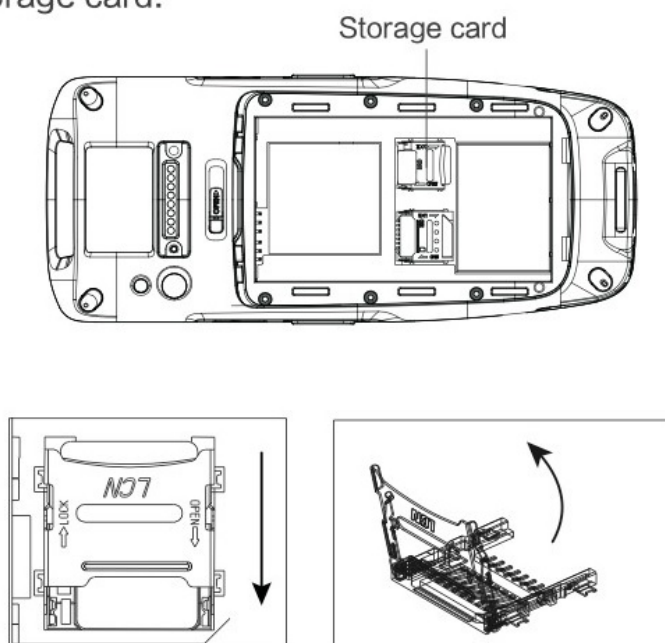

2. Insert storage card, cover up then push it to LOCK direction.

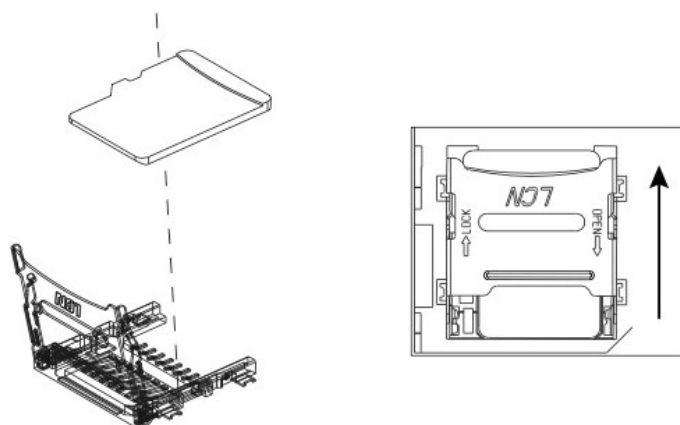

2. BARCODE SCANNER

The barcode scanner is by default turned OFF. To enable it please follow the below steps:

1. Navigate to Settings -> Scan Setting
2. Click the slider next to "Barcode scanning". If enabled should turned green.
3. Press the front or side scan keys to scan a barcode.

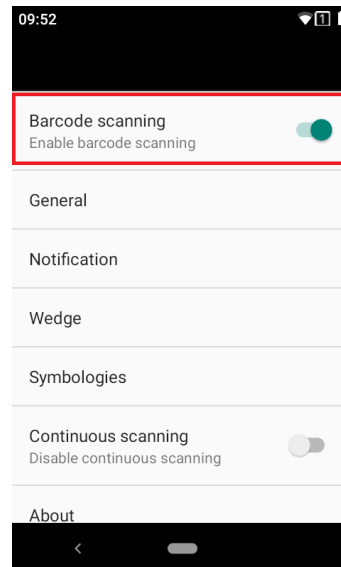
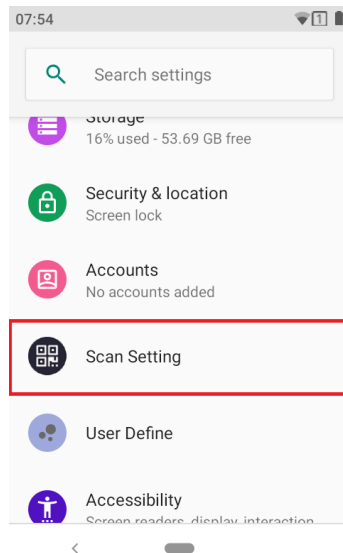

3. USER DEFINE FUNCTIONS

There is a settings menu called “user define” where you can do some specific settings. Let us go through them:

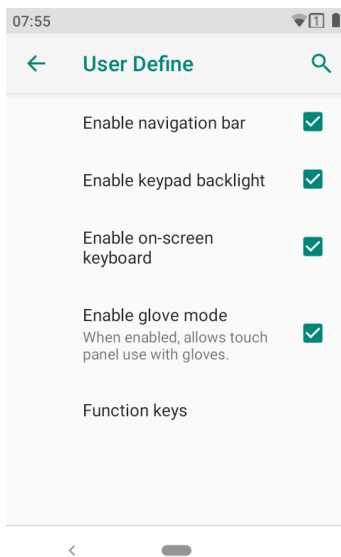
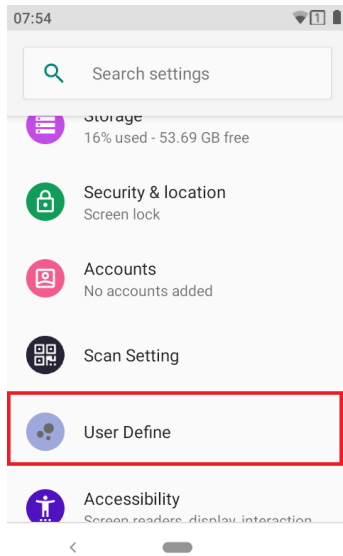

Enable navigation bar

Enable/disable the on-screen android navigation bar.

Enable keypad backlight

Enable/disable the physical keyboard backlight.

Enable on-screen keyboard

Enable/disable the on-screen soft keyboard.

Enable glove mode

When enabled, allows touch panel use with gloves.

Function keys

This settings menu allows you to key bind most buttons on the device to whatever suits your application the most. The properties field represents default key bind. The define field represents your current key bind. Simply press the key you are looking to bind/define. This will bring up a new window where you are able to choose a suitable key bind.

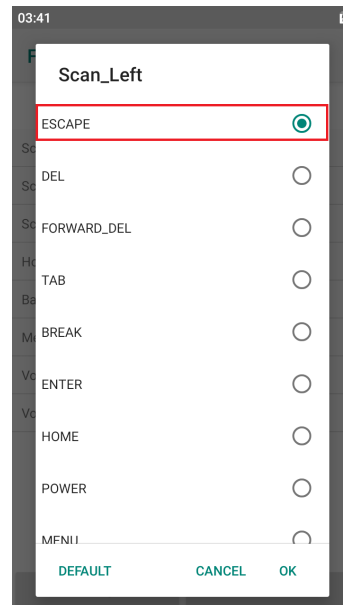
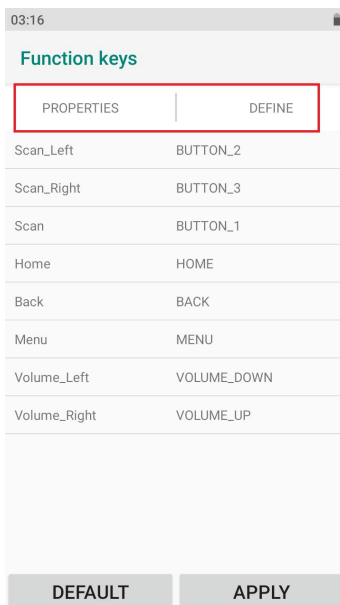
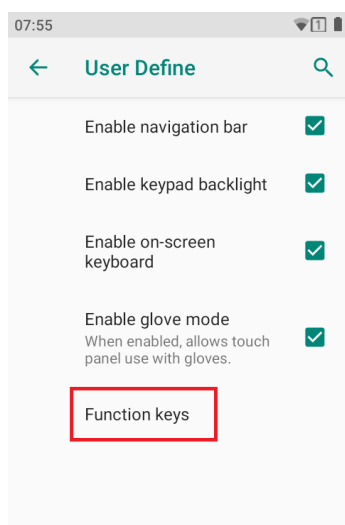

4. KEYPAD

The keypad has a total of 23 keys. Default key assignment shown below.

NOTE: Backlight is available and enabled via Settings -> User Define -> Enable keypad backlight.

